

Congratulations

on purchasing your new VTech product.

Before using this telephone, please read the

Important safety instructions

on page 39 of this manual.

This manual has all the feature operations and troubleshooting necessary to install and operate your new VTech telephone. Please review this manual thoroughly to ensure proper installation and operation of this innovative and feature rich VTech product. For support, shopping, and everything new at VTech, visit our website at www.vtechphones.com. In Canada, please visit www.vtechcanada.com.

Table of contents

Installation	1	Intercom	14
Parts checklist	1	Conference call	14
Telephone base installation	2	Transfer an external call	15
Install handset battery	3	Switch between external and intercom call	15
Desk/table bracket installation	4	Answer an incoming call during an intercom call	16
Wall mounting bracket installation	5	Chain dialing	16
Exchangeable colorful handset ring	6	Advanced operation	17
Telephone settings	7	Directory	17
Handset layout	7	Store a directory entry	17
Telephone base layout	8	Character chart	18
Ringer volume	9	Search the directory	19
Ringer tone	9	Dial a directory entry	19
Key tone	10	Edit a directory entry	20
Language	10	Delete a directory entry	20
Clear voicemail	11	About caller ID	21
Dial type	11	Call log	21
Basic operation	12	Missed calls indicator	22
Make, answer, and end calls	12	Review the call log	22
Speakerphone	12	Make CID entries ready to dial	23
Mute	12	Dial a call log entry	23
Call waiting	12	Save an entry to the directory	23
Volume	13	Delete one or all entries	24
Ringer mute	13	Call log display screen messages	24
Temporary tone dialing	13	Redial list	25
Find handset	13	Dial from redial	25

Table of contents

Delete a redial entry	25	Message window displays	34
Answering system operation	26	Handset display screen messages.	35
Answering system and voicemail.	26	Handset and telephone base indicators	37
Message capacity	26	Handset lights	37
Answering system setup	27	Telephone base lights	37
Activate the answering system	27	Handset icons	37
Set the clock	27	Battery	38
Set number of rings.	28	Important safety instructions	39
Set telephone base ringer	29	Troubleshooting	40
Set remote access code	29	Operating range	49
Set message alert tone.	29	Maintenance	49
Outgoing announcement	30	About cordless telephones.	50
Play your announcement	30	Warranty	50
Record your own announcement.	30	FCC, ACTA and IC regulations.	52
Delete your announcement.	31	The RBRC® seal	53
Message playback	31	Technical specifications	54
New message indication	31	Index	55
Options during playback	31		
Delete all messages	32		
Record and play memos	32		
Record a memo.	32		
Memo playback.	32		
Remote access	33		
Remote access commands	33		
Commands during playback mode.	33		

Installation

Parts checklist

Remember to save your sales receipt and original packaging in case it is necessary to ship your telephone for warranty service. Check to make sure the telephone package includes the following:

1. Quick start guide
2. Handsets
(3 for DS4121-3 and DS4122-3)
(4 for DS4121-4 and DS4122-4)
3. Telephone base with wall/desk bracket
4. Batteries
(3 for DS4121-3 and DS4122-3)
(4 for DS4121-4 and DS4122-4)
5. Battery compartment covers
(3 for DS4121-3 and DS4122-3)
(4 for DS4121-4 and DS4122-4)
6. Telephone line cord
7. Telephone base power adapter
8. Charger adapters
(2 for DS4121-3 and DS4122-3)
(3 for DS4121-4 and DS4122-4)
9. Chargers
(2 for DS4121-3 and DS4122-3)
(3 for DS4121-4 and DS4122-4)
10. User's manual
11. Colorful handset rings
(9 for DS4121-3 and DS4122-3)
(12 for DS4121-4 and DS4122-4)



1. Quick start guide



2. Handsets

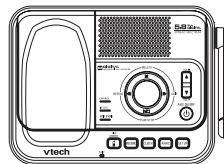

3. Telephone base with wall/desk bracket



4. Batteries



5. Battery compartment covers



6. Telephone line cord

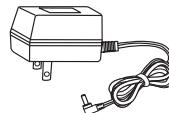

7. Telephone base power adapter



8. Charger adapters



9. Chargers



10. User's manual

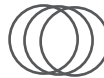

11. Colorful handset rings

note

- To purchase replacement batteries, visit our website at www.vtechphones.com or call 1 (800) 595-9511 in the United States. In Canada, go to www.vtechcanada.com or call 1 (800) 267-7377.

note

- Use only the AC power adapter supplied with this telephone.
- The power adapters are intended to be correctly oriented in a vertical or floor mount position.
- Your telephone base comes with the desktop bracket installed. You may remove the bracket before plugging in the telephone line and power adapter if it obstructs the installation process.

Installation

Telephone base installation

Install the telephone base as shown below. Make sure that the electrical outlet is not controlled by a wall switch. If you subscribe to high-speed internet service (Digital Subscriber Line - DSL) through your telephone lines, you must have a DSL filter between the telephone base and the telephone wall jack. The filter will prevent noise and caller ID problems caused by DSL interference. Please contact your DSL service provider for more information about DSL filters.

1. Plug the bigger power adapter into the power jack at the bottom of the telephone base and the smaller power adapters into the chargers. Route cords through slots and plug the power adapter into an electrical outlet not controlled by a wall switch.
2. Plug one end of the telephone line cord into the telephone line jack at the bottom of the telephone base. Route the telephone line cord through the slot, then plug the other end of the cord into a telephone wall jack.

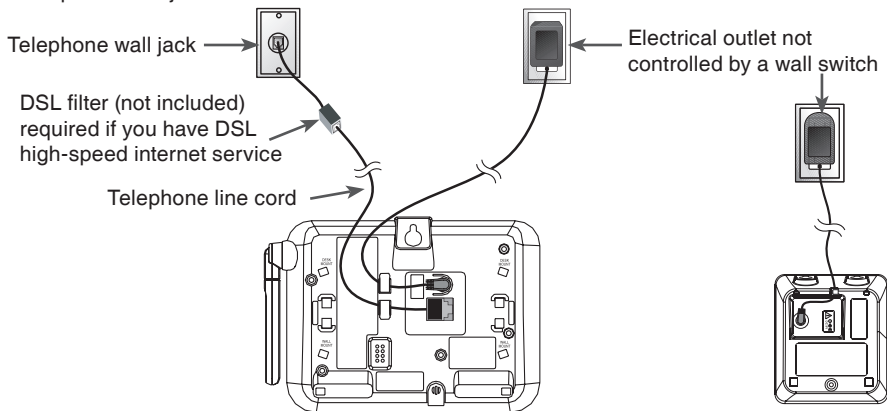

Installation

Install handset battery

1. If the battery compartment cover is on the handset, press the indentation and slide the cover to remove.
2. Align the two holes of the battery plug with the socket pins in the handset battery compartment, matching the red and black wires to the color-coded label, then snap the plug securely into place.
3. Place the battery in the compartment with the wires in the upper left corner.
4. Position the battery compartment cover and slide it up until it clicks into place.

For optimal performance, we recommend that you charge the handset for 16 hours. You can keep the battery charged by returning the handset to the telephone base after each use. When the battery power is fully depleted, a full recharge takes about 16 hours. When the battery is fully charged, it provides approximately eight hours of talk time or four days of standby time.

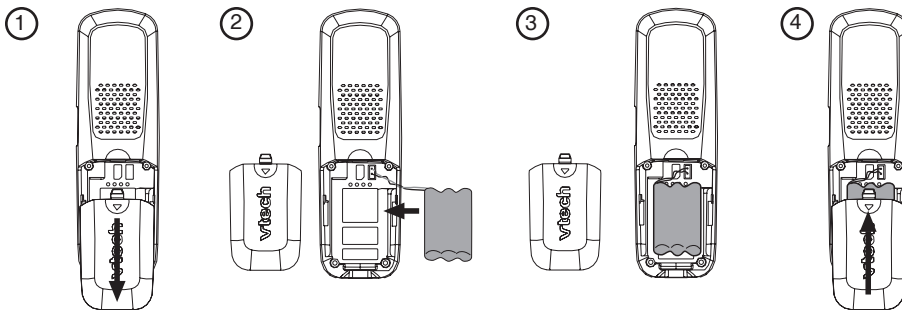

note

- If the handset will not be used for a long period of time, disconnect and remove the battery to prevent possible leakage.
- To purchase replacement batteries, visit our website at www.vtechphones.com or call 1 (800) 595-9511. In Canada, go to www.vtechcanada.com or call 1 (800) 267-7377.

note

- Your telephone base comes with the desktop bracket installed. You may remove the bracket before plugging in the telephone line and power adapter if it obstructs the telephone base installation process (see page 2).

Installation

Desk/table bracket installation

Your telephone base comes with a desktop bracket already installed.

To remove the desktop bracket:

- Press both upper tabs firmly inward and then pull the bracket upward until it is released from the grooves.

To install the desktop bracket:

1. Position the desktop bracket on the bottom of the telephone base.
2. Insert the lower tabs of the bracket into the grooves marked **DESK MOUNT**, then snap the upper tabs into place.

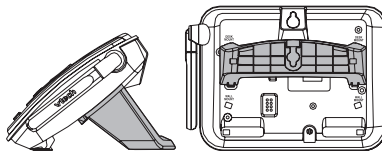

Installation

Wall mounting bracket installation

Your telephone base comes with a desktop bracket installed. If you prefer to mount your telephone on the wall, it is designed to mount on a standard telephone wall plate.

To install the wall mounting bracket:

1. First, remove the bracket from the telephone base by carefully pressing on the tabs until the bracket is released.
2. Next, rotate the bracket so that the hole for the wall mounting studs is in the same orientation as the mounting hole on the back of the telephone base.
3. Insert the lower tabs of the bracket into the grooves marked **WALL MOUNT** in the telephone base, then snap the upper tabs into place.

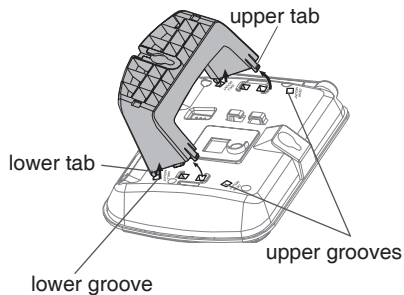

Installation

Exchangeable colorful handset ring

Your telephone comes with additional colorful handset rings. Change the ring to suit your mood or match your room decor.

To remove the handset ring:

1. Insert your thumbnail into the slot underneath the **MENU/SELECT** button.

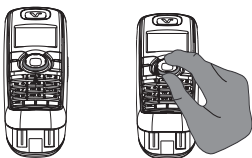

2. Lift up the colorful handset ring.

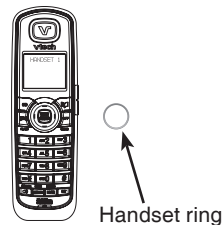

To install a new handset ring:

1. Align the desired handset ring against the **MENU/SELECT** button.



2. Press the colorful handset ring downward until it clicks into place.

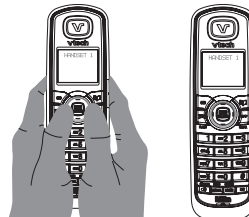

Telephone settings

Handset layout

1. Earpiece

2. **CID** (caller ID)

Press to display caller ID information.

3. **TALK/FLASH**

Press to make or answer a call. During a call, press to receive an incoming call if call waiting is activated.

4. Dial pad keys (0-9, *, #)

5. **SPEAKER** (speakerphone)

Press to activate handset speakerphone. Press again to resume normal handset use.

6. **REDIAL/PAUSE**

Press to view the redial memory. Press and hold to insert a dialing pause when entering numbers.

7. Microphone

8. Handset display

9. **Directory**

Press to display the directory entries.

10. **VOL ▲/▼** (volume)

Press to increase or decrease the listening volume during a conversation.

Press to adjust the ringer volume while the handset is not in use.

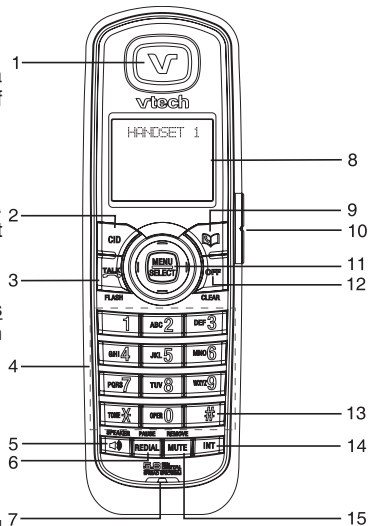

11. **NavKey/MENU/SELECT**

Press the center NavKey to display menus. Press the up or down NavKey or to navigate through menus. Press the left or right NavKey or to navigate through menus. Press the center NavKey to select a highlighted menu item.



12. **OFF/CLEAR**

During a call, press to hang up. While using the menus, press to return to the previous menu. While predialing, press to delete digits.

13. **#**

Press repeatedly to display other dialing options when reviewing the call log (page 23).

14. **INT** (intercom)

Press to initiate an intercom conversation between handsets. Press to transfer a call.

15. **MUTE/REMOVE**

While on a call, press to mute the microphone. While reviewing the call log, press to delete an individual entry, or press and hold to clear the entire call log. While entering or editing a name or number, press to delete a character.

Telephone settings

Telephone base layout

1. Message window
2. ►/SKIP
3. VOL ▲/▼ (volume +/-)
4. ANS ON/OFF (Answer on/off)
5. ►/■/PLAY/STOP
6. Antenna
7. SET UP
8. ANNC (announcement)
9. CLOCK
10. RECORD
11. FIND HANDSET
12. Microphone
13. VOICEMAIL light
14. IN USE light
15. CHARGE light
16. ◀/REPEAT
17. X/DELETE

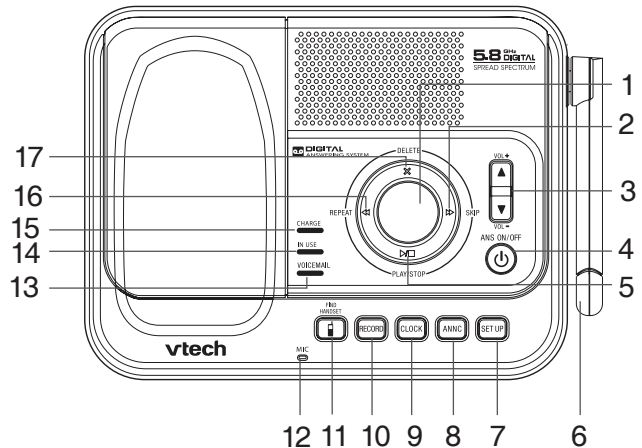

Telephone settings







Ringer volume (handset)

You can adjust the ringer volume either by the volume control on the right side of the handset or in the handset menu. To change the ringer volume:

1. Press **VOL ▲/▼** to display the current volume level on the screen when the handset is not in use.
2. Press **VOL ▲** or **VOL ▼** to choose the desired volume level. When finished, the new volume level will be saved.

-OR-







Press the center NavKey  to display the menu when the handset is not in use.

3. Press the up or down NavKey  or  to select **RINGER VOLUME**, then press the center NavKey  to confirm.
4. Press the left or right NavKey  or  to adjust the volume. A sample of each ringer volume will be played when scrolling through the choices.
5. Press the center NavKey  to save. You'll hear a confirmation tone.

Ringer tone

This feature allows you to choose the ringer tone for incoming calls.

To choose a ringer tone:

1. Press the center NavKey  to display the menu when the handset is not in use.
2. Press the up or down NavKey  or  to select **RINGER TONE**, and then press the center NavKey  to confirm.
3. Press the up or down NavKey  or  to choose the desired ringer tone. A sample of the ringer tone will be played when scrolling through the choices.
4. Press the center NavKey  to save. You'll hear a confirmation tone.

```
>RINGER VOLUME
  RINGER TONE
```

```
RINGER VOLUME
■■■■■
```

```
>RINGER TONE
  KEY TONE
```

```
RINGER TONE
1
```

note







- The ringer will be off if the volume is set to zero, and a ringer off icon  will be displayed.
- If the ringer volume is turned off, the sample of the ringer will not be heard while scrolling through the options in **RINGER TONE**.
- The telephone base ringer volume is set separately. See page 28 for details.

Telephone settings

Key tone

The handset beeps whenever you press any of the handset keys. You may turn the key tone feature on or off.

To change the setting:

1. Press the center NavKey  to display the menu when the handset is not in use.
2. Press the up or down NavKey  or  to select **KEY TONE**, then press the center NavKey .
3. Press the up or down NavKey  or  to alternate between **ON** or **OFF**, then press the center NavKey . You'll hear a confirmation tone.







```
>KEY TONE  
LANGUAGE
```

```
KEY TONE  
ON
```

Language

The language menu allows you to select from **ENGLISH**, **FRANÇAIS** or **ESPAÑOL** to be used for the handset display.

To change the setting:

1. Press the center NavKey  to display the menu when the handset is not in use.
2. Press the up or down NavKey  or  to reach **LANGUAGE**, then press the center NavKey .
3. Press the up or down NavKey  or  to scroll through the choices, then press the center NavKey . You'll hear a confirmation tone.

```
>LANGUAGE  
CLR VOICE MAIL
```

```
LANGUAGE  
ENGLISH
```

Telephone settings





Clear voicemail

If you subscribe to voicemail services offered by your local telephone service provider, **NEW VOICE MAIL** and  will appear on the handset, and the **VOICEMAIL** light on the telephone base will flash when you have new voicemail messages.

After you have listened to all new voicemail messages, the indicators on both the handset and telephone base will be turned off automatically.

Use the clear voicemail feature when the telephone indicates that there is new voicemail but there is none (for example, when you have accessed your voicemail from a different telephone line while away from home). Clearing the voicemail waiting indicator only turns off the indicators; it does not delete your voicemail message(s). If there actually are new voicemail messages, your local telephone company will continue to send the signal which will turn the indicators back on.







To turn off these indicators manually:

1. Press the center NavKey  to display the menu when the handset is not in use.
2. Press the up or down NavKey  or  to select **CLR VOICE MAIL**, and then press the center NavKey .
3. Press the center NavKey  to confirm when **TURN INDICATOR OFF?** displays, or press **OFF/CLEAR** to return to the previous menu.

Dial type

The dial type is preset for tone dialing.

To change the setting:

1. Press the center NavKey  to display the menu when the handset is not in use.
2. Press the up or down NavKey  or  to select **DIAL TYPE** and then press the center NavKey .
3. Press the up or down NavKey  or  to choose between **TONE** or **PULSE**, and then press the center NavKey  to confirm.
4. You'll hear a confirmation tone.

Changes made to the dial type on any one handset will be applied to all.

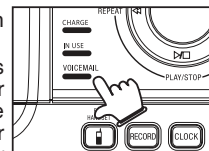

>CLR VOICE MAIL
DIAL TYPE

TURN INDICATOR
OFF?

>DIAL TYPE
DIRECTORY

DIAL TYPE
TONE

note

- Your telephone service provider may alert you to new messages with a stutter (broken) dial tone. Contact your service provider for details.

note

- The screen displays the elapsed time as you talk (in hours, minutes and seconds).
- While entering a number, press **MUTE/REMOVE** or **OFF/CLEAR** to backspace and delete; **press and hold REDIAL/PAUSE** to insert a dialing pause.

Basic operation

Make, answer, and end calls

1. To make a call, press **TALK/FLASH** or **SPEAKER**, and then dial the number.

-OR-

Dial the number and then press **TALK/FLASH** or **SPEAKER**.

2. To answer a call, press **TALK/FLASH**, **SPEAKER** or any of the dial pad keys (0-9, #, *).

3. To end a call, press **OFF/CLEAR** or put the handset in the telephone base or charger.

Speakerphone

During a call, press **SPEAKER** to switch between speakerphone and normal handset use.

Mute

The mute function allows you to hear the other party while the other party cannot hear you.

1. During a call, press **MUTE/REMOVE** on the handset.
2. The screen will display **MUTE**.
3. Press **MUTE/REMOVE** again to resume the conversation.

Call waiting

If you subscribe to call waiting service from your telephone company, you will hear an alert tone if there is an incoming call while you are on another call. Press **TALK/FLASH** to answer the new incoming call. Press **TALK/FLASH** again to return to the original call.

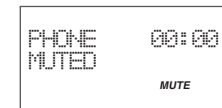
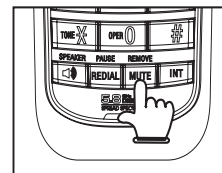
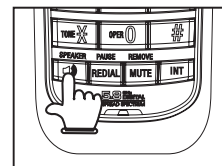
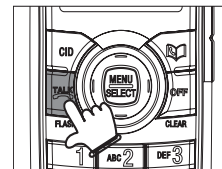

Basic operation

Volume

During a call, use the volume button on the right side of the handset to adjust the listening volume.

- Press **VOL ▲** or **VOL ▼** to adjust the volume to a comfortable level.

Ringer mute

You can mute the ringer temporarily when the telephone is ringing.

- Press **OFF/CLEAR** or **MUTE/REMOVE** on the handset to temporarily silence the ringer. The next call will ring normally.

Temporary tone dialing

If you have pulse (rotary) service, you can change from pulse dialing to touch tone during a call by pressing **TONE***. This is useful if you need to send touch tone signals for access to telephone banking or long distance services. After ending your call, your phone will return to pulse dialing mode.

Find handset

This feature allows the telephone base to page all the handsets.

1. Press **FIND HANDSET** on the telephone base. All the handsets will ring and the screens display **** PAGING ****.
2. Press **FIND HANDSET** again on the telephone base to stop paging; or press **TALK/FLASH**, **|||SPEAKER** or any dial pad keys (**0-9, #, ***) on the handset.

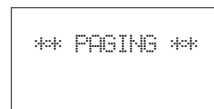
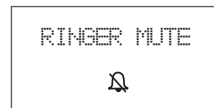
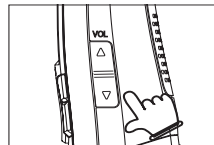

note

- If the ringer on a handset is turned off, it will not ring when you press the **FIND HANDSET** key.

note

- **X** represents the number of the handset being called and **Y** represents the number of the handset that is calling.
- If the destination handset does not answer the intercom call within 100 seconds, is in the directory, is in the call log, is on a call or out of range, the screen of the originating handset will show **UNABLE TO CALL TRY AGAIN** and return to idle mode.

Basic operation

Intercom

The intercom feature allows conversation between two registered handsets of the same system. Only two handsets can be used at a time.

1. Press **INT** to display the menu when the handset is not in use.
2. The originating handset screen will display **INTERCOM TO:**
3. Use the dial pad to select the destination handset number.
4. The originating handset screen will display **CALLING HANDSET X**.
5. The destination handset will ring and its screen will display **HANDSET Y IS CALLING**.
6. To answer the intercom call, press **TALK/FLASH**, **|||/SPEAKER**, **INT** or any dial pad keys (**0-9,#,***) on the destination handset.
7. To end an intercom call, press **INT**, **OFF/CLEAR** or place the handset back in the telephone base or charger.

Conference call

You can have a conference call with an external line and two registered handsets.

When one handset is on the line,

- Press **TALK/FLASH** or **|||/SPEAKER** on another handset to join the call.
- OR-**
1. Press **INT** to initiate an intercom call.
 2. Follow steps 3 to 5 in the **Intercom** section above.
 3. After the destination handset has answered, press and hold **INT** on the originating handset to let the destination handset join the call.

INTERCOM TO:

CALLING
HANDSET X

HANDSET Y
IS CALLING

Basic operation

Transfer an external call

You can transfer an external call from one handset to any other handset.

1. During a call, press **INT** to put the call on hold at the originating handset. The screen will display **TRANSFER TO:**
2. Use the dial pad to enter the number of the destination handset and the originating handset screen will display **CALLING HANDSET X**.
3. The destination handset will ring and its screen will display **HANDSET Y IS CALLING**.
4. To answer the call at the destination handset, press **TALK/FLASH**, **OFF/CLEAR**, **INT** or any dial pad keys (**0-9, #, ***) on the destination handset.
5. Now the party at the originating handset can have a conversation with the party at the destination handset. Both screens display **INTERCOM**.
6. Press **OFF/CLEAR** on the originating handset to transfer the call.

TRANSFER TO:

INTERCOM

OUTSIDE

Switch between external and intercom call

If you are on an external call and you wish to intercom another handset without disconnecting the external call:

1. During a call, press **INT** to put the call on hold at the originating handset. The screen will display **TRANSFER TO:**
2. Use the dial pad to enter the number of the destination handset and the originating handset screen will display **CALLING HANDSET X**.
3. The destination handset will ring and its screen will display **HANDSET Y IS CALLING**.
4. To answer the call at the destination handset, press **TALK/FLASH**, **OFF/CLEAR**, **INT** or any dial pad keys (**0-9, #, ***) on the destination handset.
5. Now the party at the originating handset can have a conversation with the party at the destination handset. Both screens display **INTERCOM**.
6. Press **INT** repeatedly on the originating handset to alternate between the external call (outside) and intercom call.

note

- If the destination handset does not pick up the intercom call, the originating handset can return to the external call by pressing **TALK/FLASH**, **OFF/CLEAR** or **INT**.
- If a call remains on hold for about 100 seconds, or if the destination handset is in the directory, in the call log, or out of range, the screen of the originating handset shows **UNABLE TO CALL TRY AGAIN** and reconnects to the external call automatically.

note

- Chain dialing can be useful if you wish to access numbers other than phone numbers (such as bank account information or access codes) from the directory, call log or redial list.

Basic operation

Answer an incoming call during an intercom call

During an intercom call, there will be an alert tone signaling an incoming call.

1. To answer the incoming call, press  **TALK/FLASH** and the intercom call will end automatically.
2. To terminate the intercom call without answering the incoming call, press **OFF/CLEAR** on the handset.

Chain dialing

This feature allows you to initiate a dialing sequence from numbers stored in the directory, call log or redial list while you are on a call.

To access a number in the directory:

1. Press  to enter the directory menu.
2. Scroll by pressing **▲** or **▼** to find the desired entry.
3. Press **MENU/SELECT** to dial the desired number when it is displayed.

To access a number in the call log:

1. Press **CID** to enter the call log menu.
2. Scroll by pressing **▲** or **▼** to find the desired entry.
3. Press **MENU/SELECT** to dial the desired number when it is displayed.



To access the last number in the redial list:

- Press **REDIAL/PAUSE** to dial.
- Press **REDIAL/PAUSE** again within two seconds to cancel the chain dialing.







Advanced operation

Directory

The directory can store up to 50 entries. Each entry may have up to 32 digits and 16 characters.

1. The directory can be accessed when the handset is not in use by pressing  once or the center NavKey  three times.
2. Press **OFF/CLEAR** to exit the menu without saving any changes.
The screen will display **DIRECTORY EMPTY** if there are no records in the directory.

Store a directory entry

1. Press the center NavKey  to display the menu when the handset is not in use, and then press the center NavKey  to enter the directory.
2. Press the up or down NavKey  or  to select **STORE**. Press the center NavKey  to select.
3. The screen displays **ENTER NUMBER**. Use the dial pad to enter the number. Press **MUTE/REMOVE** to backspace; press and hold REDIAL/PAUSE for at least three seconds to insert a dialing pause. Press the center NavKey  to save.
4. The screen displays **ENTER NAME**. Use the dial pad (see the **Character chart** on page 18) to enter the name. Press **MUTE/REMOVE** to backspace; press **#** to insert a space.
5. Press the center NavKey  to confirm. You'll hear a confirmation tone.
 - When the directory is full and you attempt to save an entry, **LIST FULL** will be displayed. An existing entry must be deleted to make room for the new entry.
 - If you attempt to save a number and name already stored in the directory, **ALREADY SAVED** will be displayed.



DIRECTORY EMPTY



>DIRECTORY
CALL LOG



>STORE
REVIEW

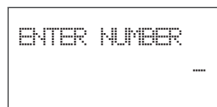

ENTER NUMBER



ENTER NAME





LIST FULL

note

- Only one handset can review the directory at a time. If a handset attempts to enter the directory while another handset is already in the directory, **NOT AVAILABLE AT THIS TIME** will be displayed.

note

- When entering a name in the directory, the first letter of each word will be capitalized automatically.
- Press the left or right NavKey  or  to move the cursor one space to the left or right.
- Press # to enter a space.

Advanced operation

Character chart

Use the dial pad and the chart below to enter a name (up to 16 characters). Each press of a particular key causes the characters to be displayed in the following order:



Number key	Characters by number of key presses								
	1	2	3	4	5	6	7	8	9
1	1	#	'	,	-	.	&		
2	A	B	C	2	a	b	c		
3	D	E	F	3	d	e	f		
4	G	H	I	4	g	h	i		
5	J	K	L	5	j	k	l		
6	M	N	O	6	m	n	o		
7	P	Q	R	S	7	p	q	r	s
8	T	U	V	8	t	u	v		
9	W	X	Y	Z	9	w	x	y	z
0	0								
*	*	?	!	/	()	@		
#	space								

- Press **MUTE/REMOVE** to backspace and erase when entering characters.
- Press and hold **MUTE/REMOVE** to delete the entire entry.

Advanced operation

Search the directory

Entries are sorted alphabetically and names beginning with numbers are presented first. An alphabetical search can be done after entering the directory.







1. Press  to enter the directory or press the center NavKey  to select **REVIEW** when in the directory.
2. Press the up or down NavKey to scroll through the directory.

-OR-

You can also use the dial pad to display the first name beginning with a letter associated with that key.

For example, press **5 (JKL)** once to find Jenny, twice to find Kristen, or three times to find Linda. If there is no name entry matching your search, the next closest matching name entry in alphabetical order will be displayed.

Dial a directory entry

1. Press  to enter the directory, or press the center NavKey  to select **REVIEW** when in the directory menu.
2. Press the up or down NavKey  or  to scroll to the desired entry, or use the alphabetical search to find it.
3. Press /FLASH or /SPEAKER to dial the entry.









>REVIEW
STORE







VTECH
800-595-9511

Advanced operation

Edit a directory entry

1. Press  to enter the directory, or press the center NavKey  three times.
2. Press the up or down NavKey  or  to scroll to the desired entry, or use the alphabetical search to find the number. Press the center NavKey  to select.
3. The screen displays **EDIT NUMBER**. Use the dial pad to edit the number. Press **MUTE/REMOVE** to backspace; press and hold **REDIAL/PAUSE** to insert a dialing pause. Press the center NavKey  to save.
4. The screen displays **EDIT NAME**. Use the dial pad (see the **Character chart** on page 18) to edit the name. Press **MUTE/REMOVE** to backspace; press # to insert a space.
5. Press the center NavKey  to confirm. You'll hear a confirmation tone.

Delete a directory entry

1. Press  to enter the directory, or press the center NavKey  to select **REVIEW** when in the directory menu.
2. Use the up or down NavKey  or  to scroll to the desired entry or use the alphabetical search to find the number.
3. Press **MUTE/REMOVE** to remove the entry. You'll hear a confirmation tone.

```
EDIT NUMBER
595-9511_
```

```
EDIT NAME
VTECH_
```

Advanced operation

About caller ID

The caller ID with call waiting feature in this telephone lets you see the name and telephone number of the caller before answering the call, even when you're already on a call. These features require services provided by your local telephone company.

Contact your telephone company if:

- you have both caller ID and call waiting, but as separate services (you may need combined service),
- you have only caller ID service, or only call waiting service, or
- you do not subscribe to any caller ID or call waiting services but wish to try these services.



You can use this telephone with regular caller ID service, and you can use its other features without subscribing to either caller ID or combined caller ID with call waiting service. There may be fees for these services, and these services may not be available in all areas.

The caller ID features will work only if both you and the caller are in areas offering caller ID service, and if both telephone companies use compatible equipment.

Call log

If you subscribe to caller ID service, information about each caller will be displayed after the first ring or second ring.

- The call log can store up to 50 entries.
- You can review, redial, and copy the entry into the directory.
- Entries are displayed in reverse chronological order, i.e. from the most recent entry to the earliest entry.
- When the call log is full, the oldest entry is deleted to make room for new incoming call information.
- **XX MISSED CALL(S)** and **NEW** will be displayed if there are new call log entries (including missed and un-reviewed calls). When all the missed calls in the call log have been reviewed, the missed calls indicator will no longer display.
- **CALL LOG EMPTY** will be displayed if there is no record in the call log.

The call log can be accessed by pressing **CID**, or by pressing the center NavKey , then **CALL LOG** then the center NavKey  again. The name (if available) and telephone number of the caller will be shown.

note

- Due to regional service differences, the caller ID information may not be available for every incoming call. In addition, the callers may intentionally block their names and/or telephone numbers.
- The time on all handsets is automatically set and updated with incoming caller ID information if you subscribe to this service.

Advanced operation



Missed calls indicator

When there are unreviewed calls in the call log, the handset screen will display **XX MISSED CALL(S)** and **NEW**.

When all the missed calls have been reviewed, the missed calls indicator will no longer display.

If you do not want to review the missed calls one by one, press and hold **OFF/CLEAR** to erase the missed calls indicator. All the entries will be considered old and kept in the call log.

Review the call log

- When in the call log, use the up or down NavKey  or  to scroll through the call log on the handset.
- The name (if available), telephone number, date and time of all incoming calls are displayed on the screen.
- There will be an error tone when the list reaches the beginning or the end of the call log.

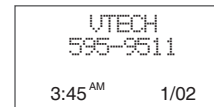
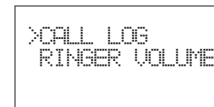
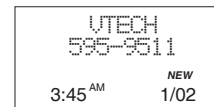
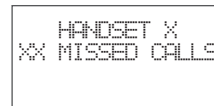

Advanced operation





Make CID entries ready to dial

Although the call log entries received are 10 digits (the area code plus the 7-digit number), in some areas, you may need to dial only the seven digits, or a 1 plus the seven digits, or a 1 plus the area code plus the seven digits. You can change the number of digits that you dial from the call log.





While reviewing the call log, press # repeatedly to display these dialing options for local and long distance numbers before dialing or saving the telephone number. See an example at right.

```
800-595-9511
1-800-595-9511
1-595-9511
595-9511
```

Dial a call log entry

1. When in the call log, use the up or down NavKey  or  to scroll to the desired entry.
2. Press /FLASH or /SPEAKER to dial the entry.

Save an entry to the directory

1. When in the call log, press the up or down NavKey  or  to scroll to the desired entry.
2. Press the center NavKey  to save the entry.
3. If the entry has a name and a number, the screen displays **SAVED**.
4. If the entry was previously saved, the screen will display **ALREADY SAVED**.
5. If the entry only has a name or a number, **EDIT NAME** or **EDIT NUMBER** will be displayed. Use the dial pad to enter the name or number and then press the center NavKey  to save the entry. You'll hear a confirmation tone.
6. If there is no caller ID information, the screen will display **UNABLE TO SAVE**.

```
SAVED
```



```
UNABLE TO SAVE
```

note

- Saving or deleting a number on one handset will automatically update all other handsets.
- Only one handset can review the directory or call log at a time. If one handset is viewing the call log and another handset attempts to review it, the screen will display **NOT AVAILABLE AT THIS TIME**.

Advanced operation

Delete one or all entries

1. While in the call log, press the up or down NavKey  or  to scroll to the desired entry.
2. Press **MUTE/REMOVE** to delete an entry.
3. Press and hold **MUTE/REMOVE** to delete all entries, the screen will display **DELETE ALL CALLS?** Press the center NavKey  and you'll hear a confirmation tone.
4. If you do not want to confirm the deletion, press **OFF/CLEAR** to return to the previous menu.



Call log display screen messages

Display:	Means:
PRIVATE NAME	The other party is blocking the name information.
PRIVATE NUMBER	The other party is blocking the telephone number information.
PRIVATE CALLER	The other party is blocking the name and number information.
UNKNOWN NAME	This caller's name is unavailable.
UNKNOWN NUMBER	This caller's number is unavailable.
UNKNOWN CALLER	No information is available about this caller.
LONG DISTANCE	This is a long distance call.

Advanced operation

Redial list





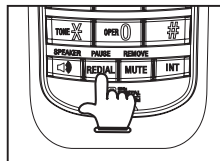

The telephone stores the five most recently dialed numbers on the redial list.

- Once there are already five entries on the redial list, the earliest entry will be deleted to make room for the latest entry.
- Entries are displayed in reverse chronological order, i.e. from the latest entry to the earliest entry.



The redial list can be accessed by pressing **REDIAL/PAUSE** when the handset is not in use.



Dial from redial

1. Press **REDIAL** then press the up or down NavKey  or  to scroll to the desired number.
2. Press /**FLASH** or /**SPEAKER** to dial the number.
3. To change the number before dialing, press the center NavKey  to select the number, and use the dial pad to change the number.
4. Press **MUTE/REMOVE** to backspace; press and hold **REDIAL/PAUSE** to insert a dialing pause. Press /**FLASH** or /**SPEAKER** to dial the number.

Delete a redial entry

1. Press **REDIAL/PAUSE**.
2. Press the up or down NavKey  or  to scroll to the desired number, or press **REDIAL/PAUSE** repeatedly to scroll to the desired number.
3. Press **MUTE/REMOVE** to delete the selected entry and you'll hear a confirmation tone.

Answering system operation

Answering system and voicemail

Your telephone has both a digital answering system and voicemail indication. Voicemail is offered by your telephone service provider (fees may apply). Your telephone's answering system and voicemail indication are independent features, and each alerts you to new messages differently. For more information on the voicemail indicators, see page 9. To listen to your voicemail, you typically dial an access number provided by your telephone company, followed by a security code or PIN. To listen to messages recorded on your digital answering system, press **▶/▶/PLAY/STOP** button on the telephone base.

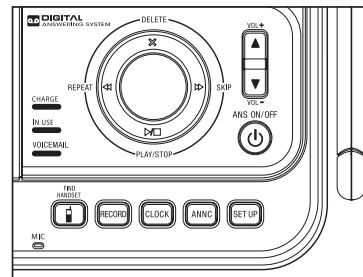

If you subscribe to caller ID/call waiting service through your telephone service provider, you can use your telephone answering system and voicemail together. Set your answering system to answer calls at least two rings earlier than your voicemail is set to answer. For example, set your voicemail to answer calls after six rings and set your answering system to answer after four rings. Some voicemail providers may program the delay before answering calls in seconds instead of rings; in this case allow six seconds per ring when determining the appropriate setting. By doing this, if you are on a call, or if the answering system is busy recording a message and you receive another call, the second caller can leave a voicemail message.

Message capacity

The answering system can record up to 99 messages. Each message can be up to four minutes in length. The total storage capacity for the announcement, messages and memos is approximately 15 minutes. Messages will remain available for replay until they are deleted.

Answering system operation

Answering system setup

Activate the answering system

The answering system must be turned on to answer and record messages. Press **ANS ON/OFF** to turn the answering system on or off. When you press **ANS ON/OFF** to turn the answering system on, it will announce “Calls will be answered,” and the **ANS ON/OFF** light will be on. When you press **ANS ON/OFF** to turn the answering system off, it will announce “Calls will not be answered,” and the **ANS ON/OFF** light will be off.

Set the clock

Before playing each message, the answering system announces the day and time of the message received. Before using the answering system, set the day, time and year, so that messages are dated correctly. If the clock is not set before new messages are recorded, the system will announce “*Time and day not set.*” before each message is played to remind you to set the clock.

1. Press **CLOCK** and the system will announce the current clock setting. The system will then announce “To set the **CLOCK**, press **CLOCK**.”
2. Press **CLOCK** again and the system will announce the year.
3. Press **►/SKIP** or **◄/REPEAT** until the system announces the correct year, then press **CLOCK**. The system will announce the hour.
4. Press **►/SKIP** or **◄/REPEAT** until the system announces the correct hour, then press **CLOCK**. The system will announce the minute.
5. Press **►/SKIP** or **◄/REPEAT** until the system announces the correct minute, then press **CLOCK**. The system will announce the day.
6. Press **►/SKIP** or **◄/REPEAT** until the system announces the correct day, then press **CLOCK**. After a confirmation tone, the system will announce the new clock setting and exit the programming mode.

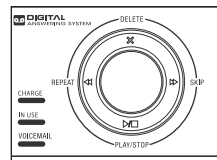
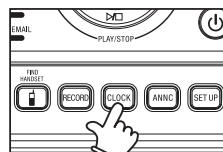
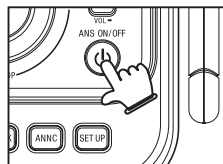

note

- Press and hold **►/SKIP** to increase or **◄/REPEAT** to decrease the minute or year by increments of 10.
- Incoming caller ID data will set the time and date (not the year). You'll need to set the year so the day of the week can be determined from caller ID data. The time will only be set automatically if you subscribe to caller ID service from your local telephone company.

Advanced operation

note

- Setting the number of rings to toll saver can save on long distance charges if you call to check your messages from a remote location because the answering system will answer the incoming call after two rings only when there are new messages.

Answering system operation

Answering system setup

The answering system uses voice prompts to guide you through the steps to setup the answering system. Press **▶/■/PLAY/STOP** anytime to save and exit the **SET UP** menu.

Set number of rings

This feature allows you to select the number of rings before the answering system answers. You can choose from two, four or six rings or toll saver. With toll saver selected, the answering system answers after two rings when there is a new message and after four rings when there are no new messages. To set the number of rings:

1. Press **SET UP** when the telephone is not in use and the system announces the current number of rings setting.
2. Press **▶/SKIP** or **◀/REPEAT** until the system announces the desired setting, then press **SET UP** to save the setting and go to the next setting, or press **▶/■/PLAY/STOP** to save and exit set up mode.

If you subscribe to caller ID/call waiting and voicemail service through your telephone service provider, you can use your telephone answering system and voicemail together. Set your answering system to answer calls at least two rings earlier than your voicemail is set to answer. For example, set your voicemail to answer calls after six rings and set your answering system to answer after four rings. By doing this, if you are on a call, or if the answering system is busy recording a message and you receive another call, the second caller can leave a voicemail message.

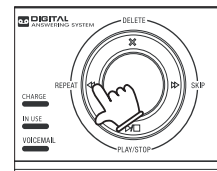
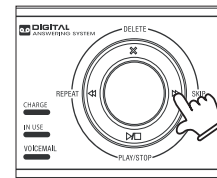
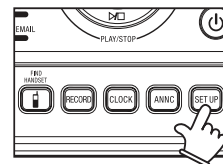

note

- The answering system must be turned on for the message alert tone to function.

Answering system operation

Set telephone base ringer

This feature allows you to select the telephone base ringer volume levels. You can choose from **HI** (high), **OF** (off) or **LO** (low).

To change the setting:

1. Press **SET UP** in idle mode until the system announces the telephone base ringer setting.
2. Press **▶/SKIP** or **◀/REPEAT** until the system announces the desired telephone base ringer volume level, then press **SET UP** to save the setting and go to the next setting or press **▶/PLAY/STOP** to save and exit set up mode.

Set remote access code

A two-digit security code is required to access the answering system remotely from any touch tone telephone. The code preset at the factory is **19**. You can set the code from **10** to **99**.

To set the remote access code:

1. Press **SET UP** when in idle mode until the system announces the remote access code setting.
2. Press **▶/SKIP** or **◀/REPEAT** to change the remote access code by one, or press and hold **▶/SKIP** or **◀/REPEAT** to change it by increments of ten. Press **SET UP** to save the setting and go to the next setting, or press **▶/PLAY/STOP** to save and exit set up mode.

Set message alert tone

This feature programs the system to beep every 10 seconds to alert you of new messages. The beeping will stop when all new messages have been reviewed.

To set the message alert tone:

1. Press **SET UP** when in idle mode until the system announces the message alert tone setting.
2. Press **▶/SKIP** or **◀/REPEAT** to alternate between on or off, then press **SET UP** to save the setting, and go to the next setting or press **▶/PLAY/STOP** to save and exit set up mode.

note

- Your announcement can be up to 90 seconds in length.
- If you receive calls when the memory is full, the telephone will ring 10 times, then answer and announce “Memory is full, enter the remote access code.”
- Announcements shorter than two seconds will not be recorded.

Answering system operation

Outgoing announcement

The outgoing announcement is the greeting callers hear when calls are answered by the answering system.

The telephone is preset with a greeting that answers calls with “Hello, please leave a message after the tone.” You can use this preset announcement, or replace it with your own. While in the **ANNC** menu, press **ANNC** again to exit at anytime.

Play your announcement

1. Press **ANNC** while in idle mode and the system will announce “Announcement, press **PLAY** or press **RECORD**.”
2. Press **▶/■/PLAY/STOP** to play, and press **▶/■/PLAY/STOP** again to stop the playback.

Record your own announcement

1. Press **ANNC** when the phone is not in use and the system will announce “Announcement, press **PLAY** or press **RECORD**.”
2. Press **RECORD** and the system announces “Record after the tone. Press **STOP** when you are done.”
3. After the tone, speak towards the microphone at the bottom front of the telephone base from about nine inches away.
4. Press **▶/■/PLAY/STOP** when finished.
5. The answering system will automatically playback the newly recorded announcement and there will be a confirmation tone. Press **▶/■/PLAY/STOP** to stop the playback at anytime.
6. Press **▶/■/PLAY/STOP** again to replay the recorded announcement. Press **RECORD** to record again (follow steps 2 to 4) if you do not like the announcement just recorded. Press **ANNC** to exit and return to idle mode.

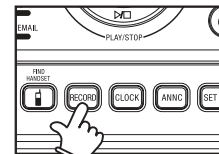
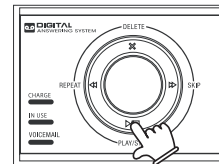
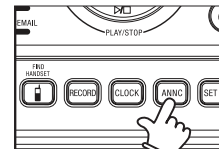

Answering system operation

Delete your announcement

1. Press **ANNC** when the phone is not in use and the system will announce “Announcement, press **PLAY** or press **RECORD**.”
2. Press **DELETE** and the system will announce “Announcement deleted.”

Message playback

1. Press **▶/■/PLAY/STOP** to listen to messages.
2. Press **▶/■/PLAY/STOP** again to stop playback.

If you have new messages waiting, you will hear only the new message (oldest first). If there are no new messages, the system will play back all messages (oldest first).

When playback begins, the total number of messages is announced, followed by the day and time of the first message to be played.

New message indication

The message display counter will flash when there are new answering system messages.

If the new message alert tone is turned on, the telephone base will beep every ten seconds when there are unreviewed messages.

Options during playback

- Press **VOL+▲/VOL-▼** to adjust the speaker volume.
- Press **▶/■/SKIP** to skip to the next message.
- Press **◀/REPEAT** to repeat the message currently playing. Press twice to listen to the previous message.
- Press **DELETE** to delete the current message. The system will advance to the next message.

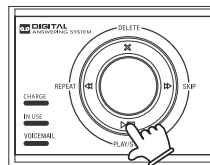
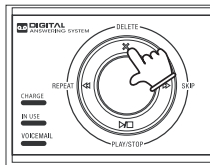

note

- When your announcement is deleted, calls will be answered with the preset announcement.
- If the system has less than five minutes of recording time left, the remaining time will be announced.
- If **F** is flashing in the message window, the memory is full. You will have to delete some messages before new ones can be recorded.

note

- Only old messages can be deleted. Messages can only be deleted after they are played.
- Memos shorter than one second will not be recorded.
- “Memory is full.” will be announced if you press **RECORD** when the memory is full.
- Each memo can be up to four minutes in length.

Answering system operation

Delete all messages

Press and hold **DELETE** when the phone is not in use to delete all old messages. The system will announce “*All old messages deleted.*”

Record and play memos

Memos are your own recorded messages used as reminders for yourself or other household members using the same answering system. They are saved, played back and deleted the same way as incoming messages.

Record a memo

1. Press **RECORD** when the phone is not in use. The system announces “*Record after the tone. Press **STOP** when you are done.*”
2. After the tone, speak towards the microphone at the bottom front of the telephone base from about nine inches away.
3. Press **▶/■ /PLAY/STOP** when you finish recording.

Memo playback

Press **▶/■ /PLAY/STOP** while in idle mode. See **Options during playback** on page 31 for other options.

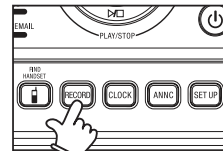

Answering system operation

Remote access

A two-digit security code is required to access the system remotely from any touch tone telephone. The factory preset code is **19**; see page 29 to change it.

1. Dial your telephone number from any touch tone telephone.
2. When the system answers and announces the greeting, enter the two-digit security code.
3. After hearing a double beep, enter one of the remote commands in the following table.
4. Hang up or press **8** to end the call.

Remote access commands:

Hang up	Saves all messages.
1	To play all messages.
2	To play new messages only.
33	To delete all old messages while no message is currently playing.
*5	To play the help menu.
5	Stop.
*7	To record the outgoing announcement.
8	To hang up the call.
0	To turn the answering system on or off.

Commands during playback mode:

3	To delete the message currently playing and announces "Message deleted."
4	To repeat the message that is playing.
44	To play the previous message.
6	To skip to the next message.

note

- If no key is pressed after entering remote access, any new messages will be played automatically.
- Once the new messages have been played, the system will announce the help menu options. If no key is pressed within 20 seconds, the remote access call is automatically disconnected.
- When the answering system is turned off, the telephone will answer after 10 rings, and announce "Please enter your remote access code."

Answering system operation

Message window displays

The message counter usually displays the total number of memos and incoming messages. See the list below for explanations of other displays in this counter.

0	No messages.
1-98	Total number of old message(s) recorded.
0-98 (flashing)	Total number of new and old message(s) recorded. The telephone base may have lost and regained power.
99 & F (alternating)	Memory is full with total number of messages recorded.
1-99 (counting)	Elapsed time while recording memo or announcement (up to 90 seconds).
99 (flashing)	Recording time exceeds 99 seconds.
1-99 (flashing)	Current message number during new message playback.
1-99	Current message number during old message playback.
1-8	Current volume level while adjusting.
10-99	Current remote access code while setting.
ON (or) OF	Current answering system status (on or off).
02, 04, 06, tS	Current number of rings while setting.
--	System is answering a call, or being set the time and date, or being accessed remotely.
-- (flashing)	System is being programmed or initialized.

Handset display screen messages

ALREADY SAVED	The telephone number you have entered is already stored in the directory.
CALL LOG EMPTY	There are no call log entries.
CALLING HANDSET X	Calling another handset.
CONNECTING...	The cordless handset is searching for the telephone base.
CHARGING	A handset with low battery has been placed in the telephone base or charger to recharge.
DIRECTORY EMPTY	There are no directory entries.
ENDED	You have just ended a call.
HANDSET Y IS CALLING	Another system handset is calling.
INTERCOM	The handset is on an intercom call.
INCOMING CALL	There is an incoming call.
INTERCOM ENDED	The handset is terminating an intercom call.
LINE IN USE	A handset or another telephone on the same line is in use.
LIST FULL	The directory is full.
LOW BATTERY	The battery needs to be recharged.
MICROPHONE ON	MUTE has been turned off and the person on the other end can hear you.
NEW VOICE MAIL	There are new voicemail message(s) from the local telephone company.
NO LINE	There is no telephone line connected.

Handset display screen messages

NO SIGNAL, CALL ENDED	Communication between handset and telephone base is lost during a call.
NOT AVAILABLE AT THIS TIME	One handset is already viewing the call log or directory and another handset attempts to review it.
OUTSIDE	Connected to the external call during call transfer.
PAGING	The cordless handset locator has been activated.
PHONE	The handset is in use.
PLACE IN CHARGER	The battery is very low. The handset should be placed in the telephone base or charger.
RINGER MUTE	The ringer is muted temporarily during incoming call.
SAVED	Your operation has been saved.
SPEAKER	The handset speakerphone is in use.
UNABLE TO CALL TRY AGAIN	You have attempted to make an intercom call, but the handset you are calling is out of range or on an external call.
UNABLE TO SAVE	You are attempting to save caller ID entry with no name or number.
WARNING CHECK BATTERY!	The battery is not installed or not installed properly in the handset. -OR - The battery needs to be replaced. -OR - An incorrect battery has been installed by mistake. Use only the supplied VTech battery or equivalent.
XX MISSED CALLS	There are un-reviewed calls in your call log.

Handset and telephone base indicators





Handset lights

	<ul style="list-style-type: none">• On when the handset speakerphone is in use.
--	---

Telephone base lights

IN USE	<ul style="list-style-type: none">• Flashes when there is an incoming call or another telephone on the same line is in use.• On when the handset is in use.
VOICEMAIL	<ul style="list-style-type: none">• Flashes when you have new voicemail. Voicemail is offered by your telephone service provider.
CHARGE	<ul style="list-style-type: none">• On when the handset is in the telephone base or charger and is charging.
ANS ON/OFF	<ul style="list-style-type: none">• On when the answering system is on.

Handset icons

MUTE	<ul style="list-style-type: none">• Microphone is muted.
	<ul style="list-style-type: none">• Ringer off.
NEW	<ul style="list-style-type: none">• New call log entries.
NEW VOICE MAIL 	<ul style="list-style-type: none">• New voicemail received from the local telephone company.
SPEAKER 	<ul style="list-style-type: none">• In speakerphone mode.
Battery indicator 	<ul style="list-style-type: none">• Cycles (low, medium, and full) when handset battery is charging.• Flashes when the battery is low and needs charging.• Displays solid when the battery is fully charged.

Battery

After the battery is fully charged, you can expect the following performance:

Operation	Operating time
While in handset use (talking*)	8 hours
While in speakerphone mode (talking*)	3 hours
While not in use (standby*)	96 hours

* Operating times are approximate. Your results may vary.

** Handset is off the telephone base but not in use.

The battery needs charging when:

- A new battery is installed in the handset.
- The telephone beeps when taken off the telephone base.
- Battery indicator on the handset screen is flashing.

CAUTION:

To reduce the risk of fire, read and follow these instructions:

- Use only the battery(ies) provided or equivalent. To order a replacement, visit our website at www.vtechphones.com or call 1 (800) 595-9511. In Canada, go to www.vtechcanada.com or call 1 (800) 267-7377.
- Do not dispose of the battery(ies) in a fire. They may explode. Check with local waste management codes for special disposal instructions.
- Do not open or mutilate the battery(ies). Released electrolyte is corrosive and may cause burns or injury to the eyes or skin. The electrolyte may be toxic if swallowed.
- Exercise care in handling batteries in order not to create a short circuit with conductive materials such as rings, bracelets, and keys. The battery and/or conductor may overheat and cause burns.
- Charge the battery(ies) provided with or identified for use with this product only in accordance with the instructions and limitations specified in this manual.

WARNING:

TO PREVENT FIRE OR SHOCK HAZARD, DO NOT EXPOSE THIS PRODUCT TO WATER OR ANY TYPE OF MOISTURE.

Important safety instructions

When using your telephone equipment, basic safety precautions should always be followed to reduce the risk of fire, electric shock and injury, including the following:

1. Read and understand all instructions.
2. Follow all warnings and instructions marked on the product.
3. Unplug this product from the wall outlet before cleaning. Do not use liquid or aerosol cleaners. Use a damp cloth for cleaning.
4. Do not use this product near water (for example, near a bathtub, kitchen sink, or swimming pool).
5. Do not place this product on an unstable table, shelf, stand or other unstable surfaces.
6. Slots and openings in the back or bottom of the telephone base and handset are provided for ventilation. To protect them from overheating, these openings must not be blocked by placing the product on a soft surface such as a bed, sofa or rug. This product should never be placed near or over a radiator or heat register. This product should not be placed in any area where proper ventilation is not provided.
7. This product should be operated only from the type of power source indicated on the marking label. If you are not sure of the type of power supply in your home, consult your dealer or local power company.
8. Do not allow anything to rest on the power cord. Do not install this product where the cord may be walked on.
9. Never push objects of any kind into this product through the slots in the base or handset as they may touch dangerous voltage points or create a short circuit that could result in a risk of fire or electric shock. Never spill liquid of any kind on the product.
10. To reduce the risk of electric shock, do not disassemble this product, but take it to an authorized service facility. Opening or removing parts of the base or handset other than specified access doors may expose you to dangerous voltages or other risks. Incorrect reassembling can cause electric shock when the product is subsequently used.
11. Do not overload wall outlets and extension cords as this can result in the risk of fire or electric shock.
12. Unplug this product from the wall outlet and refer servicing to an authorized service facility under the following conditions:
 - A. When the power supply cord or plug is damaged or frayed.
 - B. If liquid has been spilled onto the product.
 - C. If the product has been exposed to rain or water.
 - D. If the product does not operate normally by following the operating instructions. Adjust only those controls that are covered by the operation instructions, as improper adjustment of other controls may result in damage and often requires extensive work by an authorized technician to restore the product to normal operation.
 - E. If the product has been dropped and the base and/or handset has been damaged.
 - F. If the product exhibits a distinct change in performance.
13. Avoid using a telephone (other than cordless) during an electrical storm. There is a remote risk of electric shock from lightning.
14. Do not use the telephone to report a gas leak in the vicinity of the leak.
15. Only put the handset of your telephone next to your ear when it is in normal talk mode.
16. The power adapters are intended to be correctly oriented in a vertical or floor mount position. The prongs are not designed to hold the plug in place if it is plugged into a ceiling or an under-the-table/cabinet outlet.

SAVE THESE INSTRUCTIONS

www.vtechphones.com

Troubleshooting

If you have difficulty operating your telephone, please try the suggestions below. For Customer Service, visit our website at www.vtechphones.com or call 1 (800) 595-9511. In Canada, go to www.vtechcanada.com or call 1 (800) 267-7377.

Problem	Suggestion
My telephone does not work at all.	<ul style="list-style-type: none">• Make sure the battery is installed and charged correctly (pages 3 and 38). For optimum daily performance, return the cordless handset to the telephone base or charger after use.• Make sure the power adapter is securely plugged into an outlet not controlled by a wall switch.• Make sure the telephone line cord is plugged firmly into the telephone base and the telephone wall jack.• Unplug the electrical power to the telephone base. Wait for approximately 15 seconds, then plug it back in. Allow up to one minute for the cordless handset and telephone base to synchronize.• Charge the battery in the cordless handset for at least 16 hours.• Remove and re-insert the battery. If that still does not work, it may be necessary to purchase a new battery.• Disconnect the telephone base from the telephone wall jack and plug in a working telephone. If the other telephone does not work, the problem is probably in the wiring or the local service. Call the local telephone company.
LOW BATTERY is displayed on screen.	<ul style="list-style-type: none">• Place the handset in the telephone base or charger for recharging.• Remove and re-install the battery and use it normally until fully discharged, then recharge the handset on the telephone base or charger for 16 hours.• If the above measures do not correct the problem, the battery may need to be replaced.

Troubleshooting

Problem	Suggestion
The battery does not charge in the handset or the handset battery does not accept charge.	<ul style="list-style-type: none">• Make sure the handset is placed in the telephone base or charger correctly. The CHARGE light on the telephone base or charger should be on.• Remove and reinstall the battery, then charge for 16 hours.• If the cordless handset is in the charger or in the telephone base but the CHARGE light is not on, refer to The CHARGE light is off in this section.• It may be necessary to purchase a new battery. Please refer to the Battery section (page 38) of this user's manual.• The telephone might be malfunctioning. Please refer to the Warranty section (page 50) of this user's manual for further instruction.
The CHARGE light is off.	<ul style="list-style-type: none">• Clean the charging contacts on the cordless handset(s) and telephone base each month using a pencil eraser or a dry non-abrasive fabric.• Make sure the power adapter and telephone line cords are plugged in correctly and securely.• Unplug the power adapter. Wait for 15 seconds before plugging it back in. Allow up to one minute for the cordless handset and telephone base to reset.• The telephone might be malfunctioning. Please refer to the Warranty section (page 50) of this user's manual for further instruction.
There is no dial tone.	<ul style="list-style-type: none">• First, try all the above suggestions.• Move the cordless handset closer to the telephone base. It might be out of range.• The telephone line cord might be malfunctioning. Try installing a new telephone line cord.• Disconnect the telephone base from the telephone wall jack and connect a different telephone. If there is no dial tone on this telephone either, the problem is in your wiring or local service. Contact your local telephone company.

Troubleshooting

Problem	Suggestion
The telephone does not ring when there is an incoming call.	<ul style="list-style-type: none">• Make sure the ringer is on (page 9 for handset and page 29 for telephone base).• Make sure the telephone line cord and power adapter are plugged in properly (page 2).• The cordless handset may be too far from the telephone base. Move it closer to the telephone base.• There may be too many extension phones on the telephone line to allow all of them to ring simultaneously. Try unplugging some of them.• If the other telephones in your home are having the same problem, the problem is in the wiring or local service. Contact the local telephone company (charges may apply).• Other electronic products can cause interference to your cordless telephone. Try installing your telephone as far away as possible from the following electronic devices: wireless routers, radios, radio towers, pager towers, cellular telephones, digital telephones, intercoms, room monitors, televisions, VCRs, personal computers, kitchen appliances, and other cordless telephones.
The telephone does not ring when there is an incoming call.	<ul style="list-style-type: none">• Test a working telephone at the telephone wall jack. If another telephone has the same problem, the problem is in the telephone wall jack. Contact your local telephone company (charges may apply).• The telephone line cord might be malfunctioning. Try installing a new telephone line cord.• Re-install the battery and place the cordless handset in the telephone base.• Wait for the cordless handset to synchronize with the telephone base. Allow up to one minute for this to take place.

Troubleshooting

Problem	Suggestion
I cannot dial out.	<ul style="list-style-type: none">• First, try all the above suggestions.• Make sure there is a dial tone before dialing. It is normal if the cordless handset takes a second or two to synchronize with the telephone before producing a dial tone. Wait an extra second before dialing.• Make sure the telephone is set to the correct dial mode (pulse dial or tone dial) for the service in your area. Refer to the Dial type section of this user's manual (page 11) to set the dial mode.• If the other telephones in your home are having the same problem, the problem is in the wiring or local service. Contact your local telephone company (charges may apply).• Eliminate any background noise. Noise from a television, radio, or other appliances may cause the telephone not to dial out properly. If you cannot eliminate the background noise, first try muting the cordless handset before dialing, or dialing from another room in your home with less background noise.
My cordless handset beeps and is not performing normally.	<ul style="list-style-type: none">• Make sure the power cord is securely plugged into the telephone base. Plug the telephone base into a different working electrical outlet not controlled by a wall switch.• Move the cordless handset closer to the telephone base. It may be out of range.• Reset the telephone base by unplugging the electrical power to the base. Wait for 15 seconds and plug it back in again. Allow up to one minute for the cordless handset and the telephone base to synchronize.• Other electronic products can cause interference to your cordless telephone. Try installing your telephone as far away from these electronic devices as possible: wireless routers, radios, radio towers, pager towers, cellular telephones, intercoms, room monitors, televisions, personal computers, kitchen appliances and other cordless telephones.

Troubleshooting

Problem	Suggestion
<p data-bbox="105 215 322 291">There is interference during a telephone conversation.</p> <p data-bbox="105 334 315 410">My calls fade out when I am using the cordless handset.</p>	<ul data-bbox="357 215 1320 933" style="list-style-type: none"><li data-bbox="357 215 1110 239">• The handset may be out of range. Move it closer to the telephone base.<li data-bbox="357 246 1320 322">• Do you have DSL service? If yes, you need to have a DSL filter installed at every telephone wall jack that has a telephone connected to it (page 4). Contact your DSL service provider for filter information.<li data-bbox="357 334 1320 384">• Appliances or other cordless telephones plugged into the same circuit as the telephone base can cause interference. Try moving the appliance or telephone base to another outlet.<li data-bbox="357 394 1320 498">• Other electronic products can cause interference to your cordless telephone. Try installing your telephone as far away as possible from the following electronic devices: wireless routers, radios, radio towers, pager towers, cellular telephones, digital telephones, intercoms, room monitors, televisions, VCRs, personal computers, kitchen appliances, and other cordless telephones.<li data-bbox="357 508 1320 584">• Microwave ovens operate on the same frequency as your telephone. It is normal to experience static on your telephone while the microwave oven is operating. Do not install this telephone in the same outlet or near a microwave oven.<li data-bbox="357 594 1320 670">• If your telephone is plugged in with a modem or a surge protector, plug the telephone (or modem/surge protector) into a different location. If this doesn't solve the problem, re-locate your telephone or modem farther apart from each other, or use a different surge protector.<li data-bbox="357 680 1320 784">• The location of your telephone base can impact the performance of your cordless phone. For better reception, install the telephone base in a centralized location within your home or office, away from walls or other obstructions. In many environments, elevating the telephone base will improve overall performance.<li data-bbox="357 794 1320 870">• Disconnect the telephone base from the telephone wall jack and plug in a corded telephone. If calls are still not clear, the problem is probably in the wiring or local service. Contact your local service company (charges may apply).<li data-bbox="357 880 1320 933">• If the other telephones in your home are having the same problem, the problem is in the wiring or local service. Contact the local telephone company (charges may apply).

Troubleshooting

Problem	Suggestion
I hear other calls when using the telephone.	<ul style="list-style-type: none">• Disconnect the telephone base from the telephone wall jack. Plug in a different telephone. If you still hear other calls, the problem is probably in the wiring or local service. Call your local telephone company.
I hear noise on the cordless handset, and none of the keys or buttons works.	<ul style="list-style-type: none">• Make sure the telephone line cord is plugged in securely.
My caller ID features are not working properly.	<ul style="list-style-type: none">• Caller ID is a subscription service. You must subscribe to this service from your local telephone company for this feature to work on your telephone.• The caller may not be calling from an area which supports caller ID.• Both you and the caller's telephone companies must use equipment which are compatible with the caller ID service.• If you subscribe to DSL service, install a DSL filter to the telephone line between the telephone base and the telephone line jack. Contact your DSL service provider for filter information.
The system does not receive caller ID or the system does not display caller ID during call waiting.	<ul style="list-style-type: none">• Make sure you subscribe to caller ID with call waiting features provided by the local telephone company.• The caller may not be calling from an area which supports caller ID.• Both you and the caller's telephone companies must use equipment which are compatible with caller ID service.• If you subscribe to DSL service, install a DSL filter to the telephone line between the telephone base and the telephone line jack. Contact your DSL service provider for filter information.

Troubleshooting

Problem	Suggestion
Caller ID entries do not match the numbers I need to dial.	<ul style="list-style-type: none">• Although the call log entries you receive are 10 digits, (the area code plus the 7-digit number,) in some areas, you may need to dial only the seven digits, or a 1 plus the seven digits, or a 1 plus the area code plus the seven digits. You can change the number of digits that you dial from the call log.• While reviewing the call log, press # repeatedly to display these dialing options for local and long distance numbers before dialing or saving the telephone number.
CONNECTING... is shown in the handset display window. Why don't I get a dial tone when I try to use this telephone?	<ul style="list-style-type: none">• The handset may be out of range. Move it closer to the telephone base.• Make sure the power cord is securely plugged into the telephone base. Use a working electrical outlet that is not controlled by a wall switch.• Reset your telephone by unplugging the power adapter from the telephone base. Disconnect the battery from the cordless handset. Wait for 15 seconds, then plug in the power adapter and re-install the battery. Place the handset in the telephone base and allow up to one minute for the handset and telephone base to synchronize.• Other electronic products may prevent your handset and telephone base from communicating with each other. Try installing your telephone base as far away from these electronic devices as possible: wireless routers, radios, radio towers, pager towers, cellular telephones, intercoms, room monitors, televisions, personal computers, kitchen appliances and other cordless telephones.

Troubleshooting

Problem	Suggestion
The answering system does not answer after the correct number of rings.	<ul style="list-style-type: none">• Make sure the answering system is on. When the answering system is on, the red light on the ANSWER ON/OFF key should be lit.• If toll saver is activated, the number of rings changes to two when there are new messages waiting (page 28).• If the memory is full or if the answering system is off, the system will answer after ten rings.• In some cases, the answering system will be affected by the ringing system used by the local telephone company.
The outgoing announcement is not clear.	<ul style="list-style-type: none">• When recording the announcement, make sure you speak in a normal tone of voice about nine inches from the telephone base.• Make sure there is no background noise (television, music, traffic, etc.) when recording.
The messages on the system are very difficult to hear.	<ul style="list-style-type: none">• Press VOL+▲/VOL-▼ on the telephone base to increase the speaker volume.
The answering system does not record messages.	<ul style="list-style-type: none">• Make sure the answering system is on.• If the answering machine memory is full, it will not record new messages until some old messages are deleted.
The messages on the answering system are incomplete.	<ul style="list-style-type: none">• If a caller leaves a very long message, part of it may be lost when the system disconnects the call after 90 seconds.• If the memory on the system becomes full during a message, the system stops recording and disconnects the call.• If the caller's voice is very soft, the system may stop recording and disconnect the call.



Troubleshooting

Problem	Suggestion
The answering system does not respond to remote commands.	<ul style="list-style-type: none">• Make sure your remote access code is correct (page 29).• Make sure you are calling from a touch-tone telephone. When dialing a number, there should be tones. If there are clicks, then it is not a touch-tone telephone and cannot activate the answering system.• The answering system may not detect the remote access code when your announcement is playing. Wait until the announcement is over before entering the code.• There may be interference on the telephone line you are using. Press the dial pad keys firmly when dialing.
Common cure for electronic equipment.	<ul style="list-style-type: none">• If the telephone is not responding normally, try putting the cordless handset in the telephone base or the charger. If it does not seem to respond, try the following (in the order listed):• Disconnect the power to the telephone base.• Disconnect the battery on the cordless handset.• Wait a few minutes before connecting power to the telephone base.• Re-install the battery and place the cordless handset in the telephone base or charger.• Wait for the cordless handset to synchronize its connection with the telephone base. Allow up to one minute for this to take place.

Operating range

This cordless telephone operates with the maximum power allowed by the Federal Communications Commission (FCC). Even so, this handset and telephone base can communicate over only a certain distance - which can vary with the locations of the telephone base and handset, the weather, and the layout of your home or office.

When the handset is out of range, the handset will display **CONNECTING.... NOT AVAILABLE AT THIS TIME** will be displayed if access is denied.

If there is a call while the handset is out of range, it might not ring, or if it does ring, the call might not connect well when you press  **TALK/FLASH**. Move closer to the telephone base, then press  **TALK/FLASH** to answer the call.

If the handset moves out of range during a telephone conversation, there might be interference.

To improve reception, move closer to the telephone base.

Maintenance

Taking care of your telephone

Your cordless telephone contains sophisticated electronic parts, so it must be treated with care.

Avoid rough treatment

Place the handset down gently. Save the original packing materials to protect your telephone if you ever need to ship it.

Avoid water

Your telephone can be damaged if it gets wet. Do not use the handset outdoor in the rain, or handle it with wet hands. Do not install the telephone base near a sink, bathtub or shower.

Electrical storms

Electrical storms can sometimes cause power surges harmful to electronic equipment. For your own safety, take caution when using electrical appliances during storms.

Cleaning your telephone

Your telephone has a durable plastic casing that should retain its luster for many years. Clean it only with a soft cloth slightly dampened with water or a mild soap. Do not use excess water or cleaning solvents of any kind.

Remember that electrical appliances can cause serious injury if used when you are wet or standing in water. If the telephone base should fall into the water, **DO NOT RETRIEVE IT UNTIL YOU UNPLUG THE POWER CORD AND TELEPHONE LINE CORDS FROM THE WALL**. Then pull the unit out by the unplugged cords.

About cordless telephones

- **Privacy:** The same features that make a cordless telephone convenient create some limitations. Telephone calls are transmitted between the telephone base and the cordless handset by radio waves, so there is a possibility that the cordless telephone conversations could be intercepted by radio receiving equipment within range of the cordless handset. For this reason, you should not think of cordless telephone conversations as being as private as those on corded telephones.
- **Electrical power:** The telephone base of this cordless telephone must be connected to a working electrical outlet. The electrical outlet should not be controlled by a wall switch. Calls cannot be made from the cordless handset if the telephone base is unplugged or switched off, or if the electrical power is interrupted.
- **Potential TV interference:** Some cordless telephones operate at frequencies that may cause interference to televisions and VCRs. To minimize or prevent such interference, do not place the telephone base of the cordless telephone near or on top of a TV or VCR. If interference is experienced, moving the cordless telephone farther away from the TV or VCR will often reduce or eliminate the interference.
- **Rechargeable batteries:** This product contains either nickel-cadmium or nickel-metal hydride rechargeable batteries. Exercise care in handling batteries in order not to create a short circuit with conducting material such as rings, bracelets, and keys. The battery or conductor may overheat and cause harm. Observe proper polarity between the battery and the battery charger.
- **Nickel-metal hydride rechargeable batteries:** Dispose of these batteries in a safe manner. Do not burn or puncture. Like other batteries of this type, if burned or punctured, they could release caustic material which could cause injury.

Warranty

What does this limited warranty cover?

The manufacturer of this VTech Product warrants to the holder of a valid proof of purchase ("Consumer" or "you") that the Product and all accessories provided in the sales package ("Product") are free from defects in material and workmanship, pursuant to the following terms and conditions, when installed and used normally and in accordance with the Product operating instructions. This limited warranty extends only to the Consumer for Products purchased and used in the United States of America and Canada.

What will VTech do if the Product is not free from defects in materials and workmanship during the limited warranty period ("Materially Defective Product")?

During the limited warranty period, VTech's authorized service representative will repair or replace at VTech's option, without charge, a Materially Defective Product. If we repair the Product, we may use new or refurbished replacement parts. If we choose to replace the Product, we may replace it with a new or refurbished Product of the same or similar design. We will retain the defective parts, modules, or equipment. Repair or replacement of the Product, at VTech's option, is your exclusive remedy. VTech will return repaired or replacement Products to you in working condition. You should expect the repair or replacement to take approximately 30 days.

How long is the limited warranty period?

The limited warranty period for the Product extends for ONE (1) YEAR from the date of purchase. If VTech repairs or replaces a Materially Defective Product under the terms of this limited warranty, this limited warranty also applies to the repaired or replacement Product for a period of either (a) 90 days from the date the repaired or replacement Product is shipped to you or (b) the time remaining on the original one-year warranty, whichever is longer.

What is not covered by this limited warranty?

This limited warranty does not cover:

1. A product that has been subjected to misuse, accident, shipping or other physical damage, improper installation, abnormal operation or handling, neglect, inundation, fire, water or other liquid intrusion; or
2. A product that has been damaged due to repair, alteration or modification by anyone other than an authorized service representative of VTech; or

Warranty

3. A product to the extent that the problem experienced is caused by signal conditions, network reliability, or cable or antenna systems; or
4. A product to the extent that the problem is caused by use with non-VTech accessories; or
5. A product whose warranty/quality stickers, product serial number plates or electronic serial numbers have been removed, altered or rendered illegible; or
6. A product purchased, used, serviced, or shipped for repair from outside the United States of America or Canada, or used for commercial or institutional purposes (including but not limited to Products used for rental purposes); or
7. A product returned without valid proof of purchase (see item 2 below); or
8. Charges for installation or set up, adjustment of customer controls, and installation or repair of systems outside the unit.

How do you get warranty service?

To obtain warranty service in the United States of America, please call 1 (800) 595-9511. In Canada, please call 1 (800) 267-7377. NOTE: Before calling for service, please review the user's manual - a check of the Product controls and features may save you a service call.

Except as provided by applicable law, you assume the risk of loss or damage during transit and transportation and are responsible for delivery or handling charges incurred in the transport of the Product(s) to the service location. VTech will return repaired or replaced Product under this limited warranty. Transportation, delivery or handling charges are prepaid. VTech assumes no risk for damage or loss of the Product in transit. If the Product failure is not covered by this limited warranty, or proof of purchase does not meet the terms of this limited warranty, VTech will notify you and will request that you authorize the cost of repair prior to any further repair activity. You must pay for the cost of repair and return shipping costs for the repair of Products that are not covered by this limited warranty.

What must you return with the Product to get warranty service?

1. Return the entire original package and contents including the Product to the VTech service location along with a description of the malfunction or difficulty; and
2. Include a "valid proof of purchase" (sales receipt) identifying the Product purchased (Product model) and the date of purchase or receipt; and
3. Provide your name, complete and correct mailing address, and telephone number.

Other Limitations

This warranty is the complete and exclusive agreement between you and VTech. It supersedes all other written or oral communications related to this Product. VTech provides no other warranties for this Product. The warranty exclusively describes all of VTech's responsibilities regarding the Product. There are no other express warranties. No one is authorized to make modifications to this limited warranty and you should not rely on any such modification.

State/Provincial Law Rights: This warranty gives you specific legal rights, and you may also have other rights, which vary from state to state or province to province.

Limitations: Implied warranties, including those of fitness for a particular purpose and merchantability (an unwritten warranty that the Product is fit for ordinary use) are limited to one year from the date of purchase. Some states/provinces do not allow limitations on how long an implied warranty lasts, so the above limitation may not apply to you. In no event shall VTech be liable for any indirect, special, incidental, consequential, or similar damages (including, but not limited to lost profits or revenue, inability to use the Product or other associated equipment, the cost of substitute equipment, and claims by third parties) resulting from the use of this Product. Some states/provinces do not allow the exclusion or limitation of incidental or consequential damages, so the above limitation or exclusion may not apply to you.

Please retain your original sales receipt as proof of purchase.

FCC, ACTA and IC regulations

FCC Part 15

This equipment has been tested and found to comply with the requirements for a Class B digital device under Part 15 of the Federal Communications Commission (FCC) rules. These requirements are intended to provide reasonable protection against harmful interference in a residential installation. This equipment generates, uses and can radiate radio frequency energy and, if not installed and used in accordance with the instructions, may cause harmful interference to radio communications. However, there is no guarantee that interference will not occur in a particular installation. If this equipment does cause harmful interference to radio or television reception, which can be determined by turning the equipment off and on, the user is encouraged to try to correct the interference by one or more of the following measures:

- Reorient or relocate the receiving antenna.
- Increase the separation between the equipment and receiver.
- Connect the equipment into an outlet on a circuit different from that to which the receiver is connected.
- Consult the dealer or an experienced radio/TV technician for help.

Changes or modifications to this equipment not expressly approved by the party responsible for compliance could void the user's authority to operate the equipment.

This device complies with Part 15 of the FCC Rules. Operation is subject to the following two conditions: (1) this device may not cause harmful interference, and (2) this device must accept any interference received, including interference that may cause undesired operation. Privacy of communications may not be ensured when using this telephone.

To ensure safety of users, the FCC has established criteria for the amount of radio frequency energy that can be safely absorbed by a user or bystander according to the intended usage of the product. This product has been tested and found to comply with the FCC criteria. The handset may be safely held against the ear of the user. The telephone base shall be installed and used such that parts of the user's body other than the hands are maintained at a distance of approximately 20 cm (8 inches) or more. If you choose to use a clipping device, please make sure to only use the supplied VTech belt clip.

This Class B digital apparatus complies with Canadian ICES-003.

FCC Part 68 and ACTA

This equipment complies with Part 68 of the FCC rules and with technical requirements adopted by the Administrative Council for Terminal Attachments (ACTA). The label on the back or bottom of this equipment contains, among other things, a product identifier in the format US:AAAEQ##TXXXX. This identifier must be provided to your local telephone company upon request.

The plug and jack used to connect this equipment to premises wiring and the telephone network must comply with applicable Part 68 rules and technical requirements adopted by ACTA. A compliant telephone cord and modular plug is provided with this product. It is designed to be connected to a compatible modular jack that is also compliant. An RJ11 jack should normally be used for connecting to a single line and an RJ14 jack for two lines. See Installation Instructions in the user's manual.

The Ringer Equivalence Number (REN) is used to determine how many devices you may connect to your telephone line and still have them ring when you are called. The REN for this product is encoded as the 6th and 7th characters following the US: in the product identifier (e.g., if ## is 03, the REN is 0.3). In most, but not all areas, the sum of all RENs should be five (5.0) or less. For more information, please contact your local telephone company.

This equipment may not be used with Party Lines. If you have specially wired alarm dialing equipment connected to your telephone line, ensure the connection of this equipment does not disable your alarm equipment. If you have questions about what will disable alarm equipment, consult your telephone company or a qualified installer.

FCC, ACTA and IC regulations

If this equipment is malfunctioning, it must be unplugged from the modular jack until the problem has been corrected. Repairs to this telephone equipment can only be made by the manufacturer or its authorized agents. For repair procedures, follow the instructions outlined under the Limited Warranty.

If this equipment is causing harm to the telephone network, the telephone company may temporarily discontinue your telephone service. The telephone company is required to notify you before interrupting service. If advance notice is not practical, you will be notified as soon as possible. You will be given the opportunity to correct the problem and the telephone company is required to inform you of your right to file a complaint with the FCC. Your telephone company may make changes in its facilities, equipment, operation, or procedures that could affect the proper functioning of this product. The telephone company is required to notify you if such changes are planned.

If this product is equipped with a corded or cordless handset, it is hearing aid compatible.

If this product has memory dialing locations, you may choose to store emergency telephone numbers (e.g., police, fire, medical) in these locations. If you do store or test emergency numbers, please:

Remain on the line and briefly explain the reason for the call before hanging up.

Perform such activities in off-peak hours, such as early morning or late evening.

Industry Canada

Operation is subject to the following two conditions: (1) this device may not cause harmful interference, and (2) this device must accept any interference, including interference that may cause undesired operation.

The term "IC: " before the certification/registration number only signifies that the Industry Canada technical specifications were met.

The Ringer Equivalence Number (REN) for this terminal equipment is 0.1. The REN is an indication of the maximum number of devices allowed to be connected to a telephone interface. The termination on an interface may consist of any combination of devices subject only to the requirement that the sum of the RENs of all the devices does not exceed five.

This product meets the applicable Industry Canada technical specifications.

The RBRC® seal



The RBRC® seal on the nickel-metal-hydride battery indicates that VTech Communications, Inc. is voluntarily participating in an industry program to collect and recycle these batteries at the end of their useful lives, when taken out of service within the United States and Canada.

The RBRC® program provides a convenient alternative to placing used nickel-metal-hydride batteries into the trash or municipal waste, which may be illegal in your area.

VTech's participation in RBRC® makes it easy for you to drop off the spent battery at local retailers participating in the RBRC® program or at authorized VTech product service centers. Please call **1-800-8-BATTERY™** for information on Ni-MH battery recycling and disposal bans/restrictions in your area. VTech's involvement in this program is part of its commitment to protecting our environment and conserving natural resources.

RBRC® is a registered trademark of Rechargeable Battery Recycling Corporation.

Technical specifications

Frequency control	Crystal controlled PLL synthesizer
Transmit frequency	Telephone base: 5725-5850 MHz Handset: 2400-2483 MHz
Receive frequency	Telephone base: 2400-2483.5 MHz Handset: 5725-5850 MHz
Channels	95
Nominal effective range	Maximum power allowed by FCC and IC. Actual operating range may vary according to environmental conditions at the time of use.
Size	Handset: 139.0mm X 49.0mm X 39.0mm Telephone base: 177.1mm X 127.2mm X 100.4mm Charger: 79mm X 90.6mm X 58.4mm
Weight	Handset: 145.0 grams (including battery) Telephone base: 423.8 grams Charger: 72.74 grams
Power requirements	Handset: 3 cells AAA 3.6V 550mAh NiMH battery Telephone base: DC 9V@ 600mA Charger: DC 9V @200mA
Memory	Directory: 50 memory locations; up to 32 digits and 16 characters per location Call log: 50 memory locations

Index

A

- About caller ID 21
- About cordless telephones 50
- Activate the answering system 27
- Advanced operation 17
- Answer an incoming call during an intercom call 16
- Answer calls 12
- Answering system operation 26
- Answering system setup 27, 28

B

- Basic operation 12
- Battery 3, 38

C

- Call log 21
- Call log display screen messages 24
- Call waiting 12
- Chain dialing 16
- Character chart 18
- Clear voicemail 11
- Commands during playback mode 33
- Conference call 14

D

- Delete a directory entry 20
- Delete all messages from the answering system 32
- Delete a redial entry 25
- Delete from directory 20
- Delete your announcement 31
- Desk/table bracket installation 4
- Dial a call log entry 23
- Dial a directory entry 19
- Dial from redial 25
- Dial type 11
- Directory 17
- DSL filter 2

E

- Edit a directory entry 20
- End calls 12
- Exchangeable colorful handset ring 6

F

- FCC, ACTA and IC regulations 52
- Find handset 13

H

- Handset display screen messages 35
- Handset icons 37
- Handset layout 7
- Handset lights 37

I

- Important safety instructions 39
- Index 55
- Install handset battery 3
- Installation 1
- Intercom 14

K

- Key tone 10

L

- Language 10

M

- Maintenance 49
- Make calls 12
- Make CID entries ready to dial 23
- Memo playback 32
- Message capacity 26

Index

M

- Message playback 31
- Message window displays 34
- Missed calls indicator 22
- Mute 12

N

- New message indication 31

O

- Operating range 49
- Options during playback 31
- Outgoing announcement 30

P

- Parts checklist 1
- Play your announcement 30

R

- Record a memo 32
- Record and play memos 32
- Record your own announcement 30
- Redial list 25
- Remote access 33
- Remote access commands 33
- Review the call log 22
- Ringer mute 13

R

- Ringer tone 9
- Ringer volume 9

S

- Save an entry to the directory 23
- Search the directory 19
- Set message alert tone 29
- Set number of rings 28
- Set remote access code 29
- Set telephone base ringer 29
- Set the clock 27
- Speakerphone 12
- Store a directory entry 17
- Switch between external and intercom call 15

T

- Technical specifications 54
- Telephone base installation 2
- Telephone base layout 8
- Telephone base lights 37
- Telephone settings 7
- Temporary tone dialing 13
- Transfer an external call 15
- Troubleshooting 40

V

- Voicemail 11
- Volume 13

W

- Wall mounting bracket installation 5
- Warranty 50

VTECH TELECOMMUNICATIONS LTD.

A member of THE VTECH GROUP OF COMPANIES.

Distributed in the U.S.A. by VTech Communications, Inc., Beaverton, Oregon

Distributed in Canada by VTech Technologies Canada, Ltd., Richmond, B.C.

Copyright ©2008 for VTECH TELECOMMUNICATIONS LTD.

Printed in China.

91-001419-070-100

vtech[®]
Innovation Beyond Technology™

User's manual
www.vtechphones.com



Models:
DS4121-3/DS4122-3/
DS4121-4/DS4122-4

5.8^{PHD}
Digital