

**900 MHz  
DIGITAL SPREAD SPECTRUM  
CORDLESS PHONE  
MODEL VT 1980 / VT 1981**



**VT 1980  
VT 1981**



**VTECH COMMUNICATIONS LTD.**

Distributed in the U.S.A. by VTECH Communications, 8770 SW Nimbus Avenue/  
Beaverton, Oregon, 97008

distributed in Canada by VTECH Electronics Canada Ltd., 200-7671 Alderbridge Way,  
Richmond, B.C., V6X1Z9

copyright 1997 for **VTECH COMMUNICATIONS LTD.**

91-5015-11-00  
ISSUE 0

**IMPORTANT: BEFORE USING YOUR NEW  
PHONE, WE STRONGLY RECOMMEND YOU  
READ THIS MANUAL THOROUGHLY.**



**VTECH COMMUNICATIONS LTD.**

**INSTRUCTION  
manual**

# Table of Contents

<b>INTRODUCTION .....</b>	<b>1</b>
Parts Check List: .....	2
<b>IMPORTANT SAFETY INSTRUCTIONS .....</b>	<b>3</b>
<b>HANDSET BATTERIES .....</b>	<b>5</b>
<b>GETTING STARTED .....</b>	<b>7</b>
<b>WALL MOUNTING .....</b>	<b>9</b>
<b>HANDSET FEATURES .....</b>	<b>11</b>
Handset Diagram .....	11
<b>PHONE LED .....</b>	<b>12</b>
<b>BATT LOW LED .....</b>	<b>12</b>
<b>ON/OFF KEY .....</b>	<b>12</b>
<b>FLASH KEY .....</b>	<b>12</b>
<b>MEM KEY .....</b>	<b>12</b>
<b>RDL/P KEY .....</b>	<b>12</b>
<b>HOLD KEY .....</b>	<b>12</b>
<b>EMGCY KEY (EMERGENCY CALL) .....</b>	<b>12</b>
<b>MUTE KEY .....</b>	<b>12</b>
<b>UP KEY .....</b>	<b>12</b>
<b>DOWN KEY .....</b>	<b>12</b>
<b>* / TONE KEY .....</b>	<b>12</b>
<b>BASE UNIT FEATURES .....</b>	<b>13</b>
Base Unit Diagram .....	13
<b>CHARGE LED .....</b>	<b>13</b>
<b>IN USE LED .....</b>	<b>13</b>
<b>POWER LED .....</b>	<b>13</b>
<b>DP / TT (TONE/PULSE) SWITCH .....</b>	<b>13</b>

# INTRODUCTION

Congratulations ! You have purchased one of the best performing cordless telephones on the market!

The **VT 1980 / VT 1981** digital cordless telephone is a highly integrated system that uses Direct Sequence Spread Spectrum Technology. One of more than 16 million possible digital security codes is randomly selected every time the handset is placed in the base unit. The handset and base will recognize each other based on this security code, which minimizes the chance of another cordless phone using your telephone line. Additionally, a digital scrambling code is used during a conversation to prevent voice code leakage in the air. This scrambling code is generated from 65,000 possible combinations.

## OTHER SPECIAL FEATURES ARE:

- ONE TOUCH SPEED DIALING FOR EMERGENCY#
- 20 NUMBER SPEED DIAL MEMORY
- 20 CHANNELS OF OPERATION
- AUTOMATIC CHANNEL SEARCH AND SELECT
- REDIAL FEATURE
- 4 PROGRAMMABLE RINGER TYPES

- LOW BATTERY / OUT OF RANGE INDICATOR
- HEARING-AID COMPATIBLE RECEIVER
- EASY ANSWER - WHEN THE PHONE RINGS SIMPLY PRESS ANY KEY ON THE HANDSET TO ANSWER
- REMOVABLE BATTERY PACK
- TOUCH TONE AND PULSE DIALING
- TEMPORARY TONE MODE
- EARPIECE VOLUME CONTROL
- RINGER VOLUME PRESET
- HOLD
- MUTE
- 2.5mm HEADSET JACK FOR HANDS FREE OPERATION.

This manual is designed to familiarize you with the **VT 1980 / VT 1981**. We strongly recommend you read the manual before using your phone.

<b>OPERATING INSTRUCTIONS .....</b>	<b>14</b>
MAKING CALLS .....	14
ANSWERING CALLS .....	14
DISCONNECTING .....	14
TEMPORARY TONE .....	15
PROGRAMMING THE RINGER TYPE .....	15
MEMORY DIALING (SPEED DIALING) .....	16
PROGRAMMING SPEED DIAL NUMBERS .....	16
SPEED NUMBER DIALING .....	17
EMERGENCY SPEED NUMBER DIALING(EMGCY key) .....	17
TO CHANGE OR REPLACE A SPEED DIAL NUMBER .....	17
STORING PAUSES IN MEMORY .....	18
USING REDIAL .....	19
TO PUT A CALL ON HOLD .....	19
THE MUTE FEATURE .....	20
VOLUME CONTROL .....	20
TO PRESET THE RINGER VOLUME .....	20
<b>HANDSET CHARGING CRADLE/SPARE BATTERY CHARGER .....</b>	<b>21</b>
<b>OPTIONAL HEADSET INSTALLATION AND OPERATING INSTRUCTIONS .....</b>	<b>22</b>
<b>MAINTENANCE .....</b>	<b>24</b>
<b>IN CASE OF DIFFICULTIES .....</b>	<b>25</b>
<b>WARRANTY STATEMENT .....</b>	<b>28</b>
<b>FCC AND IC REGULATIONS .....</b>	<b>30</b>
<b>TECHNICAL SPECIFICATIONS .....</b>	<b>33</b>

# INTRODUCTION

## Parts Check List:

- Handset
- Base unit
- Battery pack
- Belt Clip
- Handset Charging Cradle/Spare Battery Charger
- Telephone line cord
- AC adaptor
- Wall mounting adaptor
- Screws and Caps

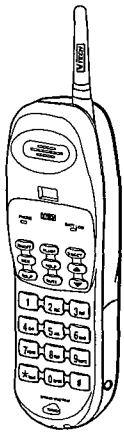

Handset

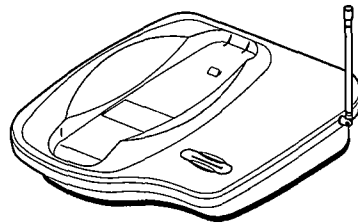

Base unit

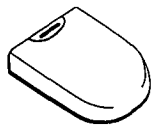

Battery pack  
(x2 for VT1980 only)

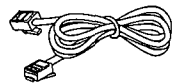

Telephone line cord

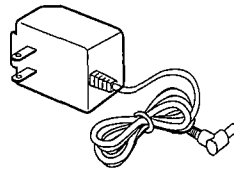

AC adaptor  
(x2 for VT1980 only)



Belt Clip

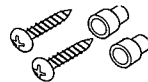

Wall Mounting screws and caps

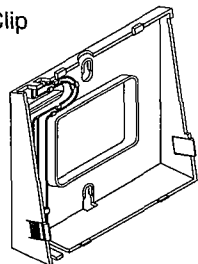

Wall mounting adaptor

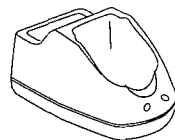

Handset Charging Cradle/Spare Battery Charger  
(VT 1980 only)

# IMPORTANT SAFETY INSTRUCTIONS

When using your telephone equipment, basic safety precautions should always be followed to reduce the risk of fire, electric shock and injury to persons, including the following:

1. Read and understand all instructions.
2. Follow all warnings and instructions marked on the product.
3. Unplug this product from the wall outlet before cleaning. Do not use liquid cleaners or aerosol cleaners. Use a damp cloth for cleaning.
4. Do not use this product near water (for example, near a bath tub, kitchen sink, or swimming pool).
5. Do not place this product on an unstable cart, stand, or table. The product may fall, causing serious damage to the product.
6. Slots and openings in the cabinet and the back or bottom are provided for ventilation. To protect it from overheating, these openings must not be blocked by placing the product on the bed, sofa, rug, or other similar surface. This product should never be placed near or

over a radiator or heat register. This product should not be placed in a built-in installation where proper ventilation is not provided.

7. This product should be operated only from the type of power source indicated on the marking label. If you are not sure of the type of power supply to your home, consult your dealer or local power company.
8. Do not allow anything to rest on the power cord. Do not locate this product where the cord will be abused by persons walking on it.
9. Never push objects of any kind into this product through cabinet slots as they may touch dangerous voltage points or short out parts that could result in a risk of fire or electric shock. Never spill liquid of any kind on the product.
10. To reduce the risk of electric shock, do not disassemble this product. If service or repair work is required, contact Vtech Customer Service at 1-800-595-9511 in the US, and 1-800-267-7377 in Canada. Opening or removing cabinet parts other than specified access doors may expose you to dangerous

# IMPORTANT SAFETY INSTRUCTIONS

voltages or other risks. Incorrect reassembling can cause electric shock when the appliance is subsequently used.

11. Do not overload wall outlets and extension cords as this can result in the risk of fire or electric shock.

12. Unplug this product from the wall outlet:

A. When the power supply cord or plug is damaged or frayed.

B. If liquid has been spilled into the product.

C. If the product has been exposed to rain or water

D. If the product does not operate normally by following the operating instructions. Adjust

only those controls that are covered by the operating instructions because improper adjustment of other controls may result in damage and will often require extensive work to restore the product to normal operation.

E. If the product has been dropped and the cabinet has been damaged.

F. If the product exhibits a distinct change in performance.

13. Avoid using a telephone (other than a cordless type) during an electrical storm. There may be a remote risk of electric shock from lightning.

14. Do not use the telephone to report a gas leak in the vicinity of the leak.

# SAVE THESE INSTRUCTIONS

# HANDSET BATTERIES

## INSTALL THE BATTERY PACK

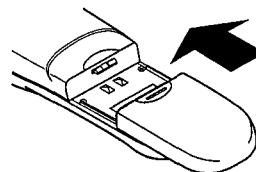

Install the battery pack by sliding it on its track upwards until it is firmly in place.

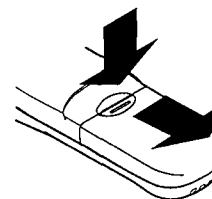

Remove the battery pack by pressing on the lock knob and sliding downward.

## CHARGING THE HANDSET BATTERIES

The handset of your VT 1980 / VT 1981 cordless telephone is powered by rechargeable batteries. The battery pack should be charged if:

- The phone produces a double beep indicating a **BATT LOW** condition when you press the **ON/OFF** key.

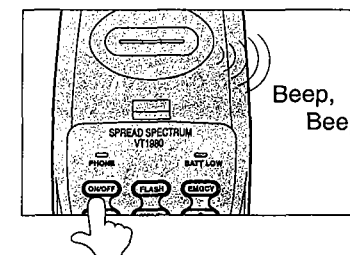

The phone double beeps when you press **ON/OFF**

- The **BATT LOW** indicator is flashing.

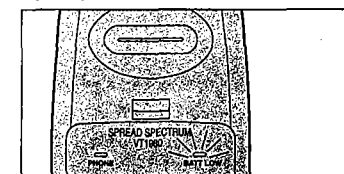

The **BATT LOW** indicator is flashing.

- The handset seems completely dead and does not beep when you press the keys.

# HANDSET BATTERIES

To charge the batteries, place the handset in the base unit. The **CHARGE** indicator will light to show the handset is seated properly and the batteries are charging.

It is recommended that the battery pack be charged initially for 24 hours. You can use your telephone before that with diminished capacity, but it is best to let the battery pack charge fully. To maximize the charge capacity of the NiCad battery pack, recharge the battery for several cycles. Once you have properly conditioned the rechargeable battery, the maximum battery life should be 4 hours of continuous talk time or 5 days of standby. After initial charging, a typical maintenance charge is 8 hours.

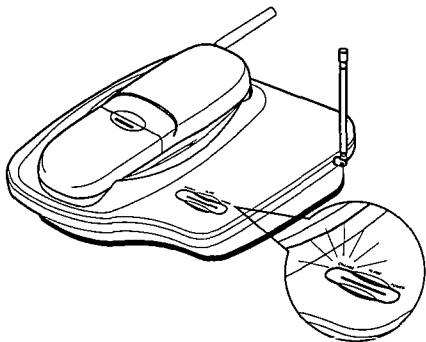

**CAUTION:** To reduce the risk of fire or injury, read and follow the instructions.

1. Use only VTECH battery.
2. Do not open or mutilate the battery. Released electrolyte is corrosive and may cause damage to the eyes or skin. It may be toxic if swallowed.
3. Exercise care in handling batteries in order not to short the battery with conducting materials such as rings, bracelets, and keys. The battery or conductor may overheat and cause burns.
4. Do not dispose of the battery in a fire. The cell may explode.

## IF THE BATTERIES DON'T RECHARGE

The battery pack can be recharged many times, but if you get a low-battery signal even after 24 hours of charging, the battery pack should be replaced.

# GETTING STARTED

## SETTING UP YOUR VT 1980 / VT 1981

1. Choose an area near an electrical outlet and a telephone wall jack.
2. **CHARGE THE HANDSET BATTERIES BEFORE USE.**

The batteries recharge automatically whenever the handset is in the base unit cradle. The batteries should be charged for 24 hours before using your phone for the first time.

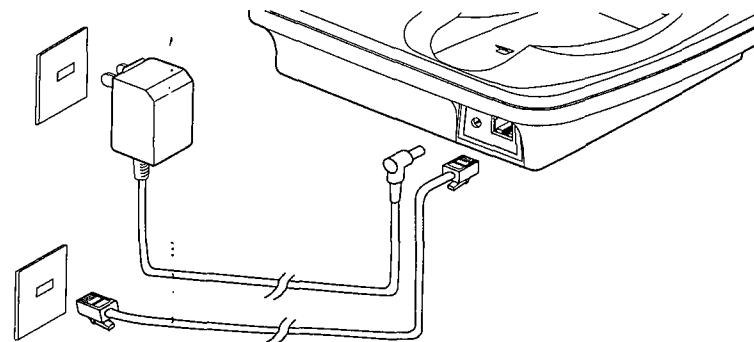

3. Plug the **AC** power adaptor into an electrical outlet and the **DC** connector to the back of the base.
4. Set the **DP / TT** switch on the base unit. If you have touch tone service on your phone line, set the switch to **TT**. If you have rotary service, set the switch to **DP**.
5. Once the battery pack is fully charged, connect the telephone line cord into the jack at the rear of the base unit. Plug the other end into a telephone wall jack. Make sure the plugs snap securely into place.

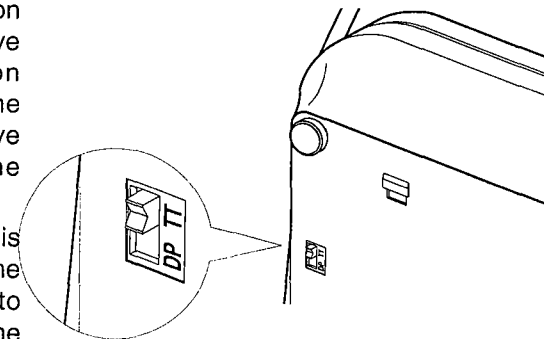

# GETTING STARTED

## 6. CHECK FOR A DIAL TONE.

After the batteries are charged, rotate the base unit antenna to an upright position. Next, pick up the handset and press the **ON/OFF** key. The **PHONE** LED should light up, and you should hear a dial tone. If not, see **IN CASE OF DIFFICULTIES**.

## CAUTION:

1. Never install telephone wiring during a lightning storm.
2. Never install telephone jacks in a wet location unless the jack is specifically designed for a wet location.
3. Never touch uninsulated telephone wires or terminals unless the telephone line has been disconnected at the network interface.
4. Use caution when installing or modifying telephone lines.

# WALL MOUNTING

Wall Installation Using Mounting Screws Provided.

The Wall Mount adaptor is designed to fit on standard Wall Mount plates. If you are using such a plate, you should start with step #4 below.

## TOOLS YOU WILL NEED :

A hammer, a nail, a pencil or ball-point pen, a Phillips head (+) screwdriver, and the Wall Mounting Template included in the back of this booklet.

## 1. CHOOSE A SPOT NEAR AN ELECTRICAL OUTLET AND A TELEPHONE JACK.

Your phone requires a modular telephone jack and a standard electrical outlet (120V AC). The power cord is six feet long; make sure there is an electrical outlet within reach of the base. The outlet should not be controlled by a wall switch. If the switch is ever turned off, the phone will not operate.

## 2. CHOOSE AND MARK THE MOUNTING POSITION.

The mounting screws should screw into a wooden stud within the wall -they will not hold securely in wallboard alone. Locate a wall stud in the area where you want to install your telephone. Use the Wall Mounting Template and a pencil to mark the screw positions on the wall over the stud. Put the template aside.

## 3. INSTALL THE MOUNTING SLEEVES AND SCREWS.

Start the screw holes by lightly tapping a nail into the marks you made on the wall. Remove the nail from the wall. Now slip the mounting sleeves onto the screws as shown, with the smaller end of the sleeve toward the screw head. Insert the screws into the holes you started. Tighten the screws until the large end of the mounting sleeve is flat against the wall.

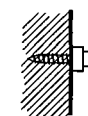
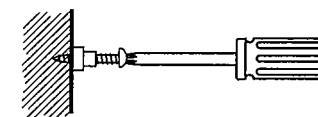
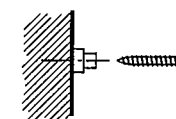
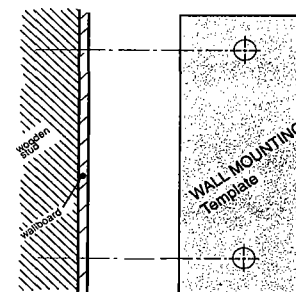

# WALL MOUNTING

## 4. POSITION THE WALL MOUNT ADAPTOR ON THE BASE.

Insert the **AC** power adaptor cord and the telephone line cord in the wall bracket notches.

Line up the tabs on the wall mount adaptor with the holes on the bottom of the base. Snap the wall mount adaptor firmly in place.

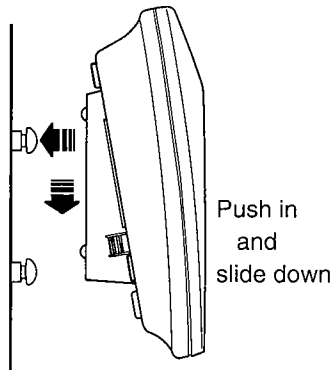

## 6. CONNECT THE TELEPHONE CORD.

The telephone line cord has a snap-in plug at each end. Insert one of the plugs into the jack on the bottom of the base. Insert the other end of the plug into the wall jack.

## 7. CONNECT THE POWER CORD.

Plug the **DC** connector into the **DC** jack at the rear of the base unit. Plug the **AC** power adaptor into an electrical outlet.

## 8. SET THE DIAL MODE SWITCH ON THE BASE UNIT.

If you have touch tone service on your phone line, set the switch to **TT**. If you have rotary service, set the switch to **DP**.

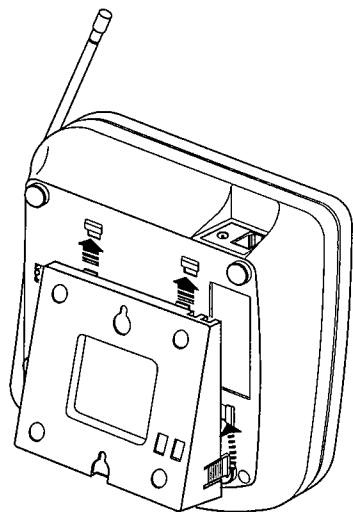

## 5. MOUNT THE BASE ON THE WALL.

Position the base so the mounting screws will fit into the holes on the bottom of the base. Position the power cord to extend down the wall the phone is to be mounted on. Slide the base down on the mounting screws until it locks into place.

# HANDSET FEATURES

## Handset Diagram

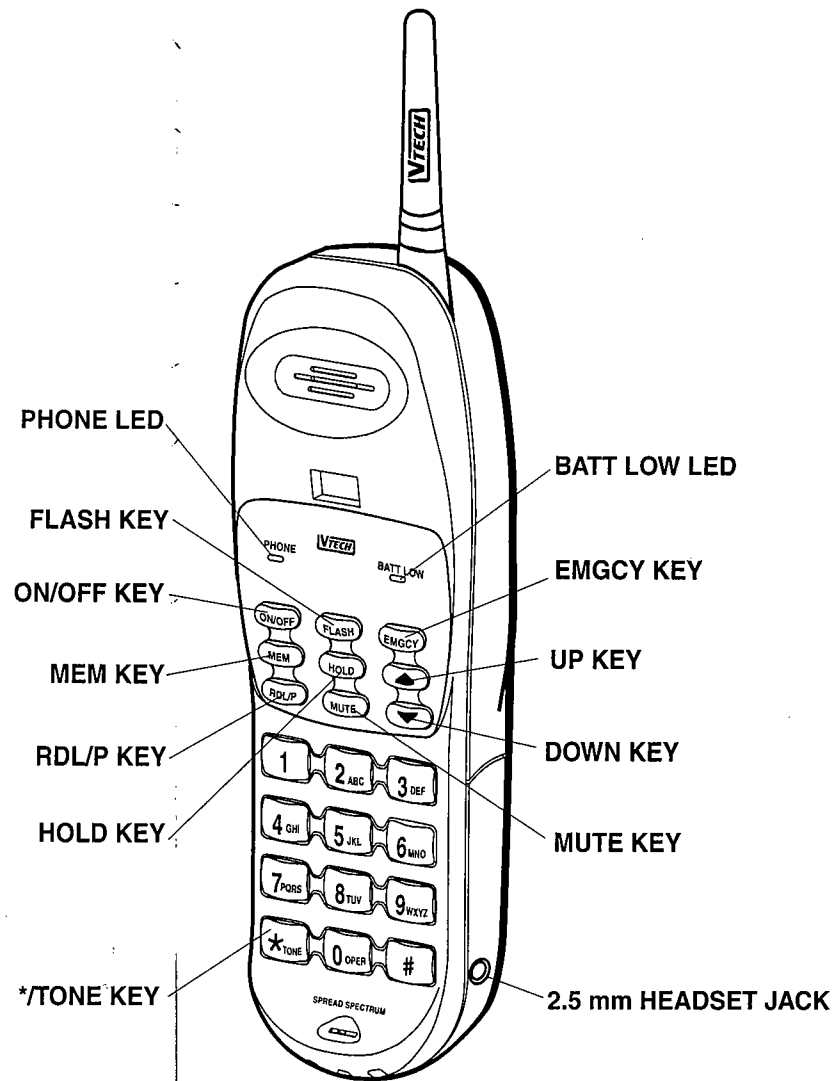



# HANDSET FEATURES

## PHONE LED

- The **PHONE LED** lights when the phone line is being used by the handset.
- It flashes during the programming mode.
- It flashes quickly when the line is on hold.

## BATT LOW LED

- The **BATT LOW LED** will flash quickly when the handset battery is getting low and needs to be recharged.
- It flashes slowly when the handset is out of the talking range or the base station is not powered up.
- The **BATT LOW LED** glows steadily when **MUTE** is activated.

## ON/OFF KEY

- Press the **ON/OFF** key to make a call or end a call.

## FLASH KEY

- Press **FLASH** to switch between calls when Call Waiting signal is heard.
- When in **OFF** mode, pressing **FLASH** and a number key (1,2,3,4) selects the ringer type.

## MEM KEY

- Used to store telephone numbers in memory and perform speed number dialing.

## RDL/P KEY

- When you hear the dial tone, pressing the RDL/P key will dial

the last number that was called on your phone.

- It can also be used for a brief **PAUSE** when programming speed numbers.

## HOLD KEY

- When using your phone, press **HOLD** to put a call on hold.
- To return to the call, press **PHONE** or **HOLD**.

## EMGCY KEY (EMERGENCY CALL)

- One-touch speed dial number which can be programmed for an emergency # or any other frequently dialed number.

## MUTE KEY

- When using your phone, press **MUTE** to temporarily turn off the microphone.
- To reactivate the microphone press **MUTE** again.

## UP KEY

- Used to increase the earpiece volume during a call.
- Used to increase the ringer volume during **OFF** mode.

## DOWN KEY

- Used to decrease the earpiece volume during a call.
- Used to decrease the ringer volume during **OFF** mode.

## \* / TONE KEY

- In **PULSE** dialing mode, it is used to switch to Temporary Tone dialing mode.

# BASE UNIT FEATURES

## Base Unit Diagram

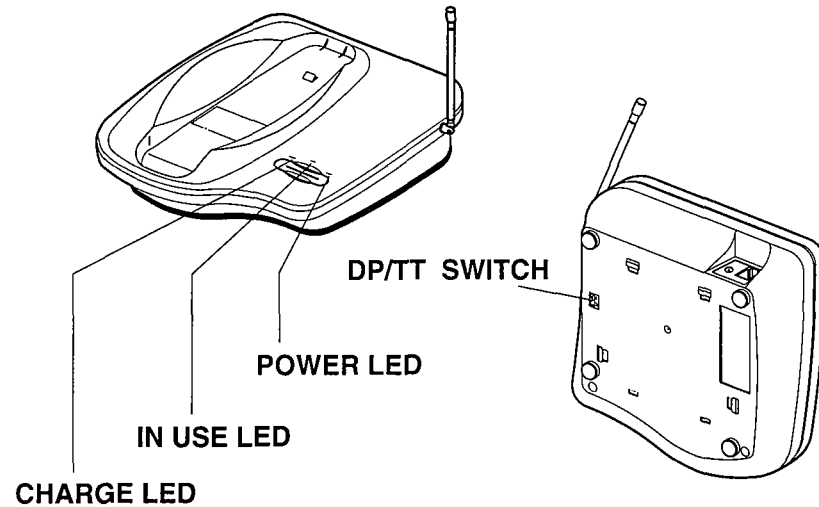

## CHARGE LED

- The **CHARGE LED** illuminates steadily when the handset is in the base cradle to indicate that the handset battery is being charged.

## IN USE LED

- Immediately after placing the handset in the base cradle, the **IN USE LED** flashes one time to indicate that initialization (assigning a new security code and channel) is completed.
- The **IN USE LED** flashes slowly when the handset is being used or an incoming call is ringing.

- The **IN USE LED** flashes quickly when the call is on hold.

## POWER LED

- Lights when the base unit is powered on.

## DP / TT (TONE/PULSE) SWITCH

- Sets the phone to **TT**(TONE) or **DP** (PULSE) dialing.

# OPERATING INSTRUCTIONS

## MAKING CALLS

Pick up the handset and press **ON/OFF**. When you hear a dial tone, dial the number. The **PHONE** LED on the handset and **IN USE** LED on the base unit will light.

If you make a mistake when dialing, press **ON/OFF** again to hang up, then press **ON/OFF** to get the dial tone again.

You must always press **ON/OFF** before you can dial on the handset. (Except when using the **EMGCY** key.)

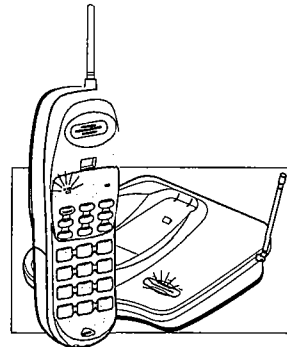

**TO MAKE CALLS :** Press **ON/OFF** dial the number

## ANSWERING CALLS

When an incoming call is ringing, the **IN USE** LED on the base unit and **PHONE** LED on the handset will flash.

To answer a call when the handset is in the base, just pick up the handset.

To answer a call when the handset is away from the base unit, just press any key on the handset. This is very useful in a dark environment; you do not have to fumble around looking for the **ON/OFF** key to answer the call.



**TO ANSWER CALLS:**  
pick up the handset,  
or press any key.

## DISCONNECTING

To end a call, either place the handset back in the base, or press **ON/OFF** on the handset.

# OPERATING INSTRUCTIONS

## TEMPORARY TONE

If you have a rotary (dial-pulse) telephone service. (**DP / TT** switch is set to **DP**), this feature allows you to enter special codes and tones to operate answering machines, use electronic banking services, calling cards, or other special services.

First, dial the call normally.

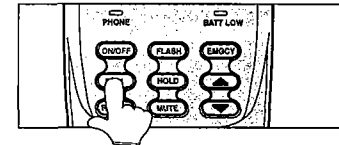

1. Dial the call

Then activate the Temporary Tone feature by pressing **TONE** (the \*key).

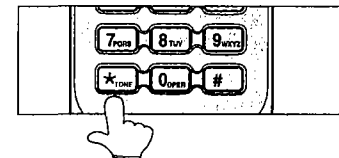

2. Press **\*TONE** key

You can then press the numbers or symbols you need, and your phone will send the proper signals.

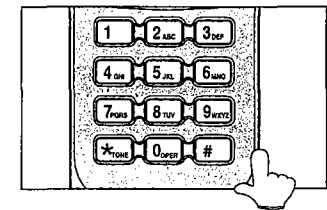

3. Phone is now in **TONE** mode.

To end the call, press **ON/OFF** or place the handset back in the base unit. The phone will automatically go back to rotary (dial-pulse) service.

If you have touch-tone service, (**DP / TT** switch set to **TT**), just dial normally. This feature is only for rotary service telephone lines.

## PROGRAMMING THE RINGER TYPE

The handset ringer is capable of four different types of ringing tones.

To program, the handset must be **OFF**.

# OPERATING INSTRUCTIONS

To select a different ringer type do the following:

1. Press **FLASH**
2. Press a key 1..4 to select a ringer type

A confirmation ring will be heard for the new ringer type.

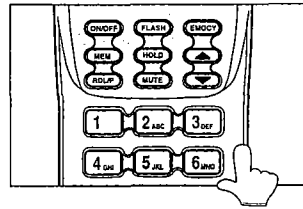

1. Press **FLASH**
2. Press a key 1..4

## MEMORY DIALING (SPEED DIALING)

The **VT 1980 / VT 1981** can store up to 21 different phone numbers that you can dial simply by pressing **MEM** and the corresponding location code (01-20), or simply by pressing the one-touch **EMGCY** key.

## TO PROGRAMMING SPEED DIAL NUMBERS

The Handset must be **OFF**.

1. Press **MEM**. The **PHONE** LED will blink to indicate that you are in the programming mode.

2. Using the dial pad, enter the number you want to store. The number can be up to 16 digits long.

3. Press **MEM** once more.

4. Press the number of the memory location you wish to store the number in (01-20). If you wish to program **EMGCY** memory, press **EMGCY**.

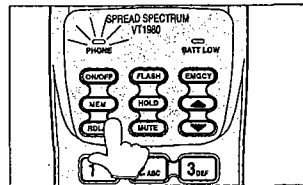

### TO PROGRAM SPEED DIAL NUMBERS

Press **MEM**  
Enter the number you want to store  
Press **MEM** again  
Enter the memory location you wish to store

The phone now exits programming mode and emits two beeps.

# OPERATING INSTRUCTIONS

## SPEED NUMBER DIALING

1. Press **ON/OFF** to get a dial tone.

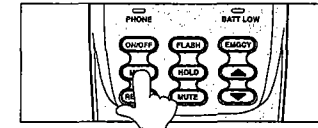

1. Press **ON/OFF**

2. Press **MEM** and the memory location number code (01-20).

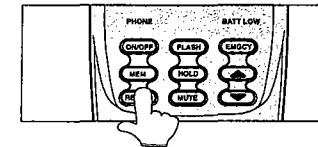

2. Press **MEM**  
3. Enter memory location

For example, to dial the number you assigned to location 18, you would press **ON/OFF, MEM, 1, 8**.

## EMERGENCY SPEED NUMBER DIALING (EMGCY key)

The **EMGCY** key is a dedicated speed dial key which is designed to be used for emergency numbers, like 911, or for another frequently dialed number. It is important to note that **YOU MUST PROGRAM THE NUMBER** which will be dialed when you press **EMGCY**. **VTECH DOES NOT PRE-PROGRAM THIS NUMBER.**

To dial using the **EMGCY** key you can simply press **EMGCY** on the handset. The phone will automatically access dial tone, and dial the number you have stored in the **EMGCY** location.

You can also dial the **EMGCY** number by pressing **ON/OFF** in advance, and then press the **EMGCY** key.

## TO CHANGE OR REPLACE A SPEED DIAL NUMBER

To change or replace a stored number in speed dial, simply enter the new number and store it in the memory location you wish to change.

# OPERATING INSTRUCTIONS

## STORING PAUSES IN MEMORY

To insert a pause in a phone number, press RDL/P at the appropriate point when storing the number. This inserts a 2 second pause. For longer pauses, press RDL/P two or more times. Each press makes the pause 2 seconds longer and is treated as a stored digit.

If your phone is connected to a **PBX** you can store the **PBX** access number and a pause before the phone number.

For example, to store **9-PAUSE-5551234** in memory location **18**, do the following:

1. Press **MEM**

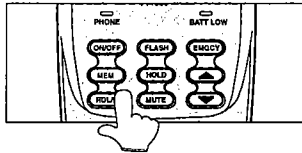

2. Press **9**

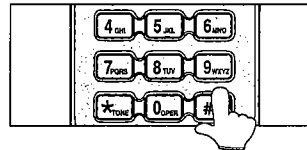

3. Press **RDL/P**

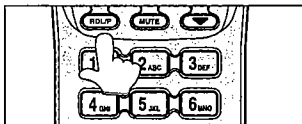

4. Press **5551234**

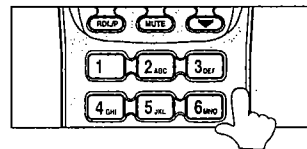

5. Press **MEM**

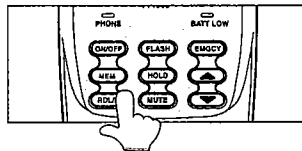

6. Press **1,8**



# OPERATING INSTRUCTIONS

## USING REDIAL

The **VT 1980 / VT 1981** cordless phone automatically stores the last number you dialed in a special redial memory.

To dial the number again, press **ON/OFF**, to get dial tone.

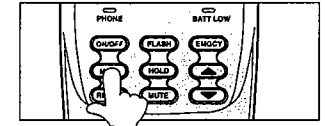

1. Press **ON/OFF**

then press **RDL/P**.

The phone will automatically dial the number.

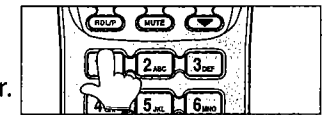

2. Press **RDL/P**

## TO PUT A CALL ON HOLD

While using your phone, you can put a call on hold by pressing **HOLD**. The **PHONE** LED on the handset will flash quickly to show a call is on hold.

To return to the call, press **ON/OFF** or **HOLD** again. If a call is on hold using the **VT 1980 / VT 1981** and the user picks up another phone on the same line, the **VT 1980 / VT 1981** will take itself off hold and turn off. Therefore, you do not have to go back to turn the phone off if you go to another extension. It is done automatically.

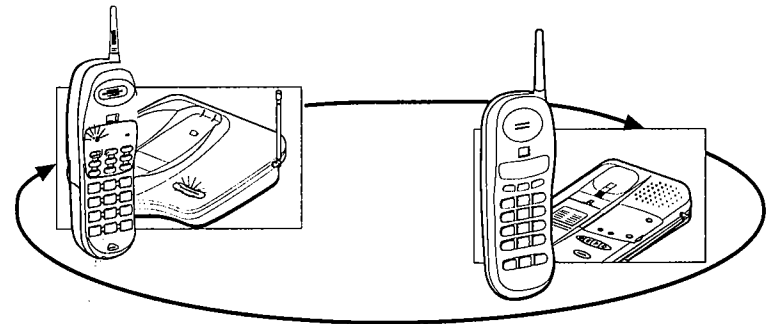

PRESS **ON/OFF** or **HOLD** (on the **VT 1980 / VT 1981**) to take call off hold, or pick up another extension on the same line.

# OPERATING INSTRUCTIONS

## THE MUTE FEATURE

When you press **MUTE** while using your phone, you can hear the caller's voice, but they cannot hear you. You can use this feature to speak to someone in the room without the caller listening. While a call is muted the **BATT LOW** LED on the handset will be on.

To go back to the two-way conversation, press **MUTE** again.

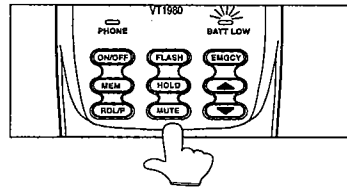

Press **MUTE**  
the caller can not hear your voice

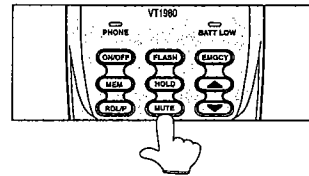

Press **MUTE** to return  
to the two-way conversation

## VOLUME CONTROL

During a call, press the (▲) **UP** or (▼) **DOWN** keys to increase or decrease the earpiece volume. Three rapid beeps will be heard when you reach the highest or lowest volume level.

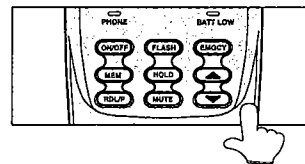

**UP** (▲) and **DOWN** (▼) keys control  
earpiece volume during a call

## TO PRESET THE RINGER VOLUME

The **VT 1980 / VT 1981** has two ringer volume levels. To preset the ringer volume, the phone must be **OFF**. Press the (▲) **UP** or (▼) **DOWN** keys, a confirmation ring will be heard for the new ringer volume level.

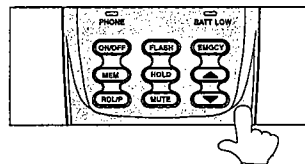

**UP** (▲) and **DOWN** (▼) keys preset  
ringer volume when phone is **OFF**

## HANDSET CHARGING CRADLE/SPARE BATTERY CHARGER

An optional handset charging cradle/Spare Battery Charger is available for use with the **VT 1980 / VT 1981**.

This allows the user to remotely charge a Spare Battery and Handset while it is away from the Base Unit.

## SETTING UP THE HANDSET CHARGING CRADLE /SPARE BATTERY CHARGER (Optional for VT 1980)

1. Choose an area near an electrical outlet.
2. Plug the AC power adaptor into an electrical outlet and the DC connector into the bottom of the charger.

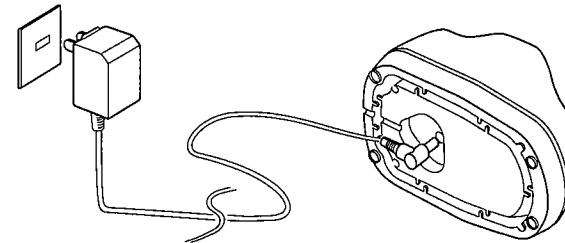

3. Place the Spare Battery in the charging slot. The Spare Battery LED will glow steadily.
4. Place the Handset in the charging base. The Handset Charging LED will glow steadily.

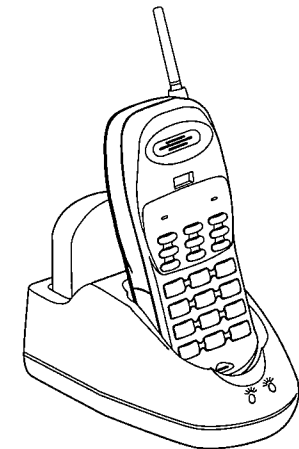

To purchase a Handset Charging Cradle / Spare Battery Charger, call VTECH Customer Service at 1-800-595-9511 in the US, in Canada at 1-800-267-7377.

## OPTIONAL HEADSET INSTALLATION AND OPERATING INSTRUCTIONS

Your VT 1980 / VT 1981 cordless telephone is equipped with a 2.5mm Headset Jack for use with an optional accessory Headset for hands-free operation.

If you choose to use the Headset option, you must do the following:

### INSTALLATION

Obtain an optional accessory Headset, which is compatible with the VT 1980 / VT 1981.

To purchase a Headset, call VTECH Customer Service at 1-800-595-9511 in the US, in Canada at 1-800-267-7377.

Once you have a compatible 2.5mm Headset, locate the Headset Jack on the Handset of your VT 1980 / VT 1981. Connect the plug on the Headset to the jack on the cordless Handset. The plug should fit securely. Do not force the connection. See illustration.

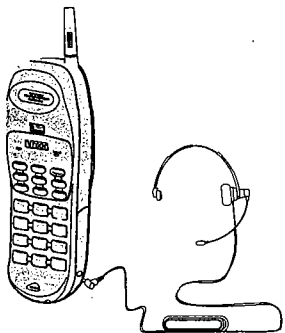

The VT 1980 / VT 1981 is also equipped with a detachable belt clip. Align the pins on the inside edge of the belt clip with the notches on the side of the VT 1980 / VT1981 Handset. The belt clip should snap securely into place. Do not force the connection. See Illustration.

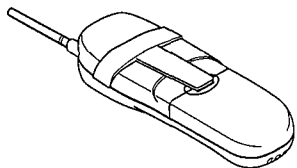

### OPERATION

Note: whenever a compatible Headset is connected to the cordless Handset, the microphone on the Handset will be MUTED. This is done to limit the effect of background noise.

The following operational characteristics apply to VTech Headsets. The same may also apply to other (non-VTech) compatible headsets, but VTech assumes no responsibility for their performance.

## OPTIONAL HEADSET INSTALLATION AND OPERATING INSTRUCTIONS

The VTech brand compatible Headset has a monaural design which is reversible, so you can wear your Headset on either the left or right ear, leaving one ear free for room conversation.

For maximum sound quality, the flexible microphone should be positioned at the corner or your mouth, about one inch from your face.



ON RIGHT EAR



ON LEFT EAR

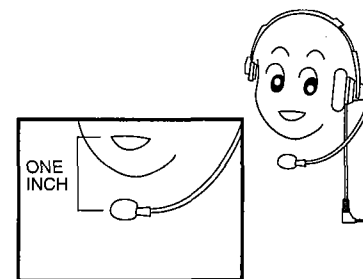

The headband can be adjusted to fit the contour of your head. Using both hands, slide the headband up or down so that it rests comfortably on your head with the speaker cushion centered against your ear.

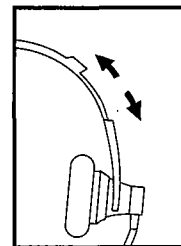
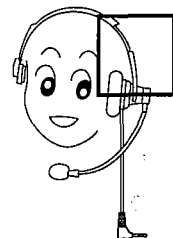

# MAINTENANCE

## TAKING CARE OF YOUR TELEPHONE

Your **VT 1980 / VT 1981** cordless telephone contains sophisticated electronic parts so it must be treated with care.

## AVOID ROUGH TREATMENT

Place the handset down gently. Save the original packing material to protect your telephone if you ever need to ship it.

## AVOID WATER

Your telephone can be damaged if it gets wet. Do not use the handset outdoors in the rain, or handle it with wet hands. Do not install your base unit near a sink, bathtub or shower.

## ELECTRICAL STORMS

Electrical storms can sometimes cause power surges harmful to electronic equipment.

For your own safety, use caution when using electric appliances during storms.

## CLEANING YOUR TELEPHONE

Your telephone has a durable plastic casing that should retain its luster for many years. Clean it only with a soft cloth slightly dampened with water or a mild soap. Do not use excess water or cleaning solvents of any kind.

# IN CASE OF DIFFICULTIES

If you have difficulty operating your phone, the suggestions below should solve the problem. If you still have difficulty after trying these suggestions, call:

**VTECH Communications at 1-800-595-9511**, In Canada call **VTECH Electronics at 1-800-267-7377**.

## Problem

## Remedy

### THE PHONE DOESN'T WORK AT ALL

- Make sure the power cord is plugged in.
- Make sure the telephone line cord is plugged firmly into base unit and the telephone wall jack.
- Make sure the batteries are properly charged. If the **BATT LOW** LED is on, the battery needs charging. If the **PHONE** LED does not light when you press **ON/OFF**, you must charge the batteries.
- If you recently installed a new battery pack, make sure it is installed correctly.

### NO DIAL TONE

- First check all the suggestions above.
- If you still don't hear a dial tone, disconnect the base unit from the telephone jack and connect a different phone. If there is no dial tone on that phone either, the problem is in your wiring or local service. Call your local telephone company.

### YOU GET NOISE, STATIC, OR A WEAK SIGNAL EVEN WHEN YOU'RE NEAR THE BASE UNIT

- Place the handset in the base momentarily to reset the security code. Then press **ON/OFF** to get a line.
- Household appliances plugged into the same circuit as the base unit can sometimes cause interference. Try moving the appliance or the base unit to another outlet.

# IN CASE OF DIFFICULTIES

Problem	Remedy
YOU GET NOISE, STATIC, OR A WEAK SIGNAL WHEN YOU'RE AWAY FROM THE BASE UNIT	<ul style="list-style-type: none"><li>• You may be out of range. Either move closer to the base, or relocate the base unit.</li><li>• The layout of your home may be limiting the range. Try moving the base unit to the second or third floor, or to some other location.</li></ul>
THE HANDSET DOES NOT RING WHEN YOU RECEIVE A CALL	<ul style="list-style-type: none"><li>• Make sure the telephone line cord is plugged firmly into the base unit and the telephone jack. Make sure the power cord is plugged in.</li><li>• You may be too far from the base unit.</li><li>• You may have too many extension phones on your telephone line to allow them all to ring. Try unplugging some of the other phones.</li></ul>
YOUR CALLER FADES IN AND OUT	<ul style="list-style-type: none"><li>• You may be nearly out of range. Move closer, or relocate the base.</li></ul>
YOU HEAR OTHER CALLS WHILE USING YOUR PHONE	<ul style="list-style-type: none"><li>• Replace the handset in the base cradle, wait a few moments and try again.</li><li>• Disconnect your base unit from the telephone jack, and plug in a regular telephone. If you still hear other calls, the problem is probably in your wiring or local service. Call your local telephone company.</li></ul>
YOU HEAR NOISE IN THE HANDSET, AND NONE OF THE KEYS OR BUTTONS WORK	<ul style="list-style-type: none"><li>• Make sure the power cord is plugged in.</li><li>• Your base unit and handset may not be operating on the same channel or security code. Place the handset in the cradle for a few moments to reload the security code and reset the channel.</li></ul>

# IN CASE OF DIFFICULTIES

Problem	Remedy
COMMON CURE FOR ELECTRONIC EQUIPMENT	<p>Electronics , like people , can sometimes get confused. If the unit does not seem to be responding normally, then try putting the handset in the cradle for 5 to 10 seconds to re-initialize the unit. If it still does not seem to respond, perform the following steps (in the order listed):</p> <ol style="list-style-type: none"><li>1. Disconnect the power to the base.</li><li>2. Disconnect the handset battery.</li><li>3. Wait a few minutes.</li><li>4. Connect power to the base.</li><li>5. Connect the handset battery.</li><li>6. Put the handset in the base to re-initialize.</li></ol>



# WARRANTY STATEMENT

## WHAT DOES OUR WARRANTY COVER ?

- Any defect in material or workmanship.

## FOR HOW LONG AFTER THE ORIGINAL PURCHASE ?

- To the original purchaser only-ONE YEAR.

## WHAT WILL VTECH DO ?

- At our option, repair or replace your unit.

## HOW DO I SEND MY UNIT, IN OR OUT OF WARRANTY ?

- In the US call VTECH Communications customer service for Return Authorization at: 1-800-595-9511, in Canada call VTECH Electronics at 1-800-267-7377.
- Properly pack your unit. Include any cables & accessories which were originally provided with the product. We recommend using the original carton and packing materials.
- Include in the package a copy of the sales receipt or other evidence of date of original purchase (if the unit was purchased within the last twelve months.)
- Print your name and address, along with a description of the defect, and include this in the package.
- Include payment for any service or repair not covered by warranty, as determined by VTECH Communications.
- Ship the unit via UPS Insured, or equivalent to:

**VTECH COMMUNICATIONS**  
**8770 SW NIMBUS AVENUE**  
**BEAVERTON, OREGON 97008**  
**IN Canada VTech Electronics**  
**Suite 200 7671 Alderbridge Way**  
**Richmond, B.C. V6X 1Z9**

VTECH Communications assumes no responsibility for units sent without prior Return Authorization.

# WARRANTY STATEMENT

## WHAT DOES OUR WARRANTY NOT COVER ?

- Batteries
- Damage from misuse, neglect, or acts of nature (lightning, floods, power surges, etc.)
- Products which may have been modified or incorporated into other products
- Products purchased and/or operated outside the USA, its territories, or Canada.
- Products serviced by the owner or a service facility not expressly authorized by VTECH Communications
- Products purchased more than 12 months from current date
- Units purchased in "AS IS" condition, or units purchased as "Distressed Merchandise".

## HOW DOES STATE LAW OR PROVINCIAL LAW RELATE TO THIS WARRANTY?

- This warranty gives you specific rights. You may also have other rights which vary from state to state or from province to province.

# FCC AND IC REGULATIONS

This equipment complies with Part 15 and 68 of the Federal Communications Commission (FCC) rules for the United States. It also complies with rules RSS-210 and CS-03 of Industry Canada (IC) for Canada.

A label is located on the underside of the base unit containing either the FCC registration number and Ringer Equivalence Number (REN) or the IC registration number. You must, upon request, provide this information to your local telephone company.

This equipment is compatible with inductively coupled hearing aids.

Should you experience trouble with this telephone equipment, please contact:

VTECH COMMUNICATIONS AT  
1-800-595-9511 in the US  
and VTECH ELECTRONICS AT  
1-800-267-7377 in Canada.

for repair / warranty information. The telephone company may ask you to disconnect this equipment from the line network until the problem has been corrected.

Your **VT 1980 / VT 1981** is designed to operate at the maximum power allowed by the FCC and IC. This means your handset and base unit can

communicate only over a certain distance - which will depend on the location of the base unit and handset and layout of your home or office.

## FCC PART 15

The equipment has been tested and found to comply with part 15 of the FCC rules. These limits are designed to provide reasonable protection against harmful interference in a residential installation. This equipment generates, uses and can radiate radio frequency energy and, if not installed and used in accordance with the instructions, may cause harmful interference to radio communications. However, there is no guarantee that interference will not occur in particular installation. If this equipment does cause harmful interference to radio or television reception, which can be determined by turning the equipment off and on, the user is encouraged to try and correct the interference by one or more of the following measures:

- Reorient or relocate the receiving antenna.
- Increase the separation between the equipment and receiver.

# FCC AND IC REGULATIONS

- Connect the equipment into an outlet or on a circuit different from that to which the receiver is connected.
- Consult the dealer or an experienced radio / TV technician for help.

## FCC PART 68

The FCC requires that you connect your cordless telephone to the nationwide telephone network through a modular telephone jack (USOC, RJ11C or RJ11W)

Your telephone company may discontinue your service if your equipment causes harm to the telephone network. They will notify you in advance of disconnection, if possible. During notification, you will be informed of your right to file a complaint with the FCC.

Occasionally your telephone company may make changes in its facilities, equipment, operation, or procedures that could affect the operation of your equipment. If so, you will be given advance notice of the change to give you an opportunity to maintain uninterrupted service.

The base unit contains no user serviceable parts. The handset contains a user replaceable battery pack.

If it is determined that your telephone equipment is malfunctioning, the FCC requires that it not be used and that it be unplugged from the modular jack until the problem has been corrected. Repairs to this telephone equipment can only be made by the manufacturer or its authorized agents or by others who may be authorized by the FCC. For repair procedures, follow the instructions outlined under the VTECH Limited Warranty.

This equipment may not be used on coin service provided by the phone company or Party lines.

The REN is useful in determining the number of devices you may connect to your telephone line and still enable the devices to ring when you receive a call. The general rule is that the REN value should not exceed 5.0A total; however, contact your local telephone company for the specific number in your area.

# FCC AND IC REGULATIONS

## IC (Industry Canada)

This telephone is registered for use in Canada.

**Notice:**The REN assigned to this device denotes the number of devices you may connect to the telephone loop which is used by the device to prevent overloading. The termination on a loop may consist of any combination of devices subjected only to the requirement that the sum of the REN does not exceed five (5.0).

**Notice:**The Industry Canada label identifies certified equipment. This certification means that the equipment meets certain telecommunications network protective, operational and safety requirements. The Department does not guarantee the equipment will operate to the user's satisfaction.

This device complies with RSS-210 of Industry Canada. Operation is subject to the following two conditions:(1) this device may not cause interference, and (2) this device must accept

any interference, including interference that may cause undesired operation of the device.

# TECHNICAL SPECIFICATIONS

## FREQUENCY CONTROL

Crystal Controlled PLL Synthesizer

## TRANSMIT FREQUENCY

902 MHz to 928 MHz  
(All twenty channels within this range)

## RECEIVE FREQUENCY

902 MHz to 928 MHz  
(All twenty channels within this range)

## NOMINAL EFFECTIVE RANGE

Maximum power allowed by FCC and IC. Actual operating range may vary according to environmental conditions at the time of use.

**SPECIFICATIONS ARE TYPICAL AND MAY CHANGE WITHOUT NOTICE**

## SIZE

Handset : 18.5cm x 6.3cm x 3.6cm  
(L x W x T) maximum  
(antenna excluded)  
Base : 20.5cm x 18.5cm x 5.5cm  
(L x W x T) maximum  
(antenna excluded)

## ANTENNA LENGTH

Handset: 6 cm  
Base : 12 cm

## WEIGHT

Handset: 250 grams  
Base : 520 grams  
Batteries: 50 grams

## POWER REQUIREMENTS

Handset : Self-contained nickel cadmium rechargeable battery supply, 3.6V nominal, 600mAh capacity.

Power Adapter :DC 9V @500mA

**VTECH VT 1980 /  
VT 1981 Cordless  
Telephone**

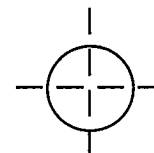

**Wall Mounting  
Template**

Use this template when wall mounting your base unit. To mark the positions of the mounting screws, hold this template against the wall, and press a pencil or pen point through the center of each crossmark.

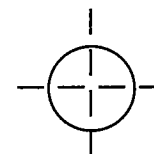

**NOTE:**

Select a spot where you can screw into a wooden stud within the wall. The mounting screws will not hold securely in plaster or wallboard alone.