



at&t

Quick start guide

TL7912

DECT 6.0 cordless headset
and handset lifter



Introduction

The TL7912 is a cordless headset and base that allows you to have handsfree phone conversations. The package also comes with the TL7100 handset lifter, making it convenient to answer and end calls right from the headset. It can be used in different ways depending on your needs. Choose from the following three options. Connect your TL7912:

- **To a traditional corded telephone** (pages 11-12). Connect the headset base to a corded telephone and install the lifter on your corded telephone. You can use the headset to remotely control the lifter for answering or hanging up a call.
- **To both a corded phone and computer** (pages 13-16). Connect the headset base to a corded telephone and install the lifter on your corded telephone. Use the USB cable to connect the headset base and your PC. You can make and answer VoIP calls through Skype™ and Microsoft Lync®, or landline calls using the **AT&T Softphone Call Manager**. You can also use the voice command feature to make or answer calls after you have installed the **AT&T Softphone Call Manager**.

Install the **AT&T Softphone Call Manager** using the **CD-ROM** provided in the package.

-OR-

Visit **www.telephones.att.com/downloads** to download the software. Unzip and install the file after download.

For installation and operation instructions of the software, refer to the **Installation and Operation Guide** which can also be found in the **CD-ROM** provided or the web site stated above.

- **To a telephone line only** (page 17). If you do not want to install the lifter on the corded handset, you can simply connect the headset to a telephone wall jack through the line splitter provided. Use the telephones on the same telephone line to make or answer calls. The headset is a supplementary device that can join the calls.

The Skype name is a trademark of Skype.

Microsoft Lync is a registered trademark of Microsoft Corporation.

Introduction

This quick start guide provides you with the basic installation and setup instructions.

You may refer to the user's manual provided in the product package for complete installation and operation instructions, or you can visit **www.telephones.att.com/manuals** to download the manual.

For customer service or product information, visit our website at **www.telephones.att.com** or call **1 (800) 222-3111**. In Canada, dial **1 (866) 288-4268**.

Quick reference guide - headset

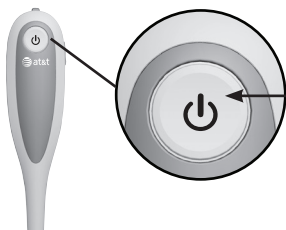

⏻ (On/off button and light)

Press to make, answer or end a call.



MUTE/VOICE

Press to mute the microphone during a call.

Press to mute the ringer in the earpiece when there is an incoming call.

Press to initiate the voice command feature when in idle mode.



Earpiece

Battery with cover attached

Remove to replace the battery.

Microphone

The microphone incorporates noise canceling technology for clearer calls.

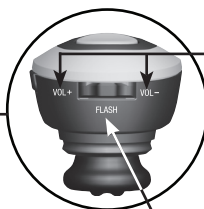

VOL+/VOL-

Slide the volume switch to the right or left to adjust the headset ringer volume while in idle mode, or the listening volume while on a call.

FLASH

Press to answer an incoming call when you receive a call waiting alert during a call.

Quick reference guide - headset base

Magnetic charging mount

Place the headset here for charging.

MUTE (light)

PHONE (mode button and light)

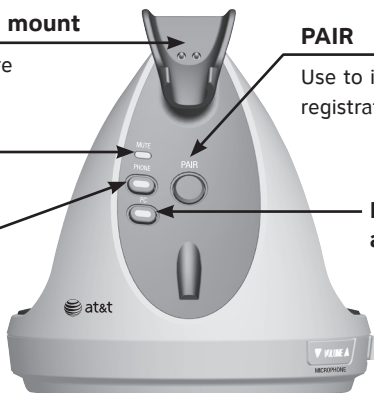

PAIR

Use to initiate headset registration or deregistration.

PC (mode button and light)

▼ VOLUME ▲/MICROPHONE

Press the volume keys on the side of the headset base to adjust the speaking volume when on a call.

USB (USB port)

Open the port cover to plug in the USB cable for use with PC mode.

LIFTER

This jack is only used to connect an AT&T handset lifter (model TL7100, purchased separately).

CORDED HANDSET CONNECTED/ YES/NO

Choose the setting based on whether you have connected to a corded handset.

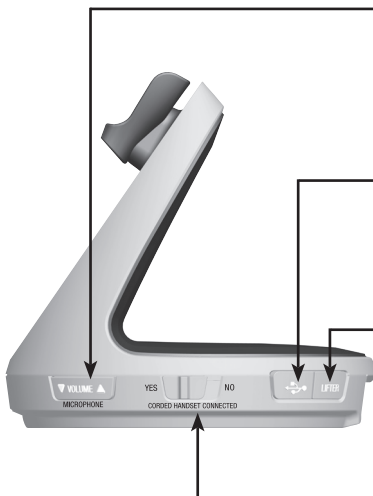

Quick reference guide - headset base



CORDED PHONE CONNECTION jack (blue dot)

This jack is only used to connect the corded phone connection cable.

TEL WALL JACK (red dot)

POWER jack (green dot)

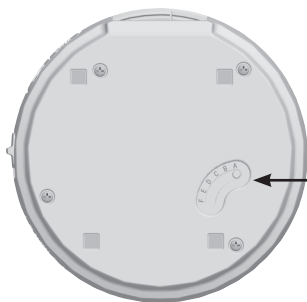

Corded handset audio adjust switch

Use this switch to adjust the corded handset audio when you have connected the headset base to a corded telephone.

Quick reference guide - handset lifter

SENSOR ADJ knob

Adjusts the sensitivity of the ring detector.

ADJUST LIFTER knob

Adjusts the height of the lifter arm.

Lifter arm

Holds the corded telephone handset.

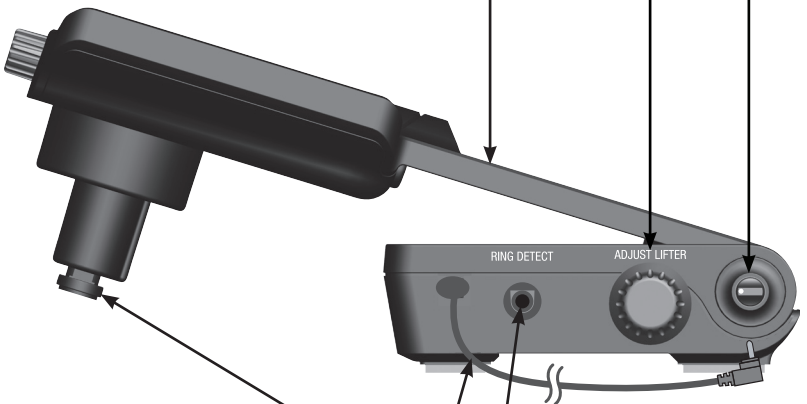

Switch hook presser

When the **CORDED HANDSET CONNECTED** switch is set to **YES**, pressing **⏻** on the headset raises or lowers the switch hook presser.

Lifter control cable

Plug this cable into the **LIFTER** jack on the headset base.

RING DETECT jack

Plug in the auxiliary ring detector.

Quick reference guide - handset lifter

RING ON/OFF

Press to turn the ring detector on or off. When the ring detector is off, the cordless headset does not ring.

Switch hook presser adjustment knob

Adjusts the position of the switch hook presser.

Small lifter pad

Holds the earpiece of the corded telephone handset.

STATUS light

On in red when the ring detector is off.

On in blue when the ring detector is on and the headset is not in use.

Flashes in blue four times every three seconds when the ring detector detects an incoming call.

Flashes in blue slowly when the switch hook presser is raised and you are on a call.

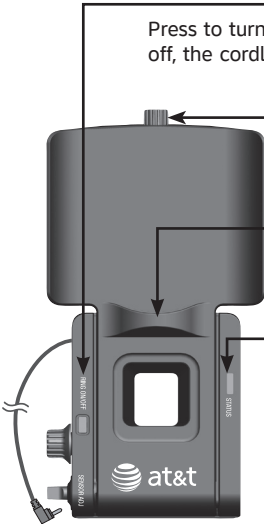

Front view

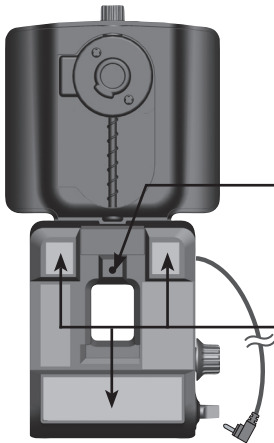

Back view

Internal ring detector

Detects the telephone ringer and sends a ring tone to the headset earpiece.

Adhesive tape

Remove the protective strips before attaching the lifter to the telephone base.

Battery installation

The battery is permanently attached to the battery compartment cover. Do not try to separate them from each other. After installing the battery pack, charge it for at least 15 minutes. You may be able to make and receive short calls. For optimal performance, charge the headset battery for at least three hours before use. When fully charged, the headset battery provides approximately 12 hours of talk time or 5 days of standby time. When the headset is not in use, recharge by returning it to the headset base.

1. Insert the battery pack into the battery compartment.

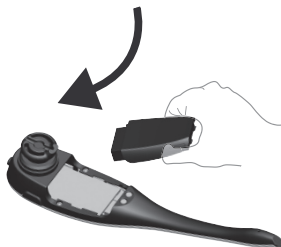

2. Press down on the battery pack until it clicks into place.

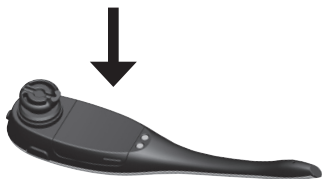

NOTES:

- Remove any headset attachment (earbud excluded) before battery replacement.
- To order a replacement battery pack (model BT191665), visit our website at **www.telephones.att.com** or call **1 (800) 222-3111**.
In Canada, dial **1 (866) 288-4268**.

Headset base installation and battery charging

After installing the battery, charge the headset by placing it in the magnetic charging mount as shown below. The  light turns on when the headset is charging.

1. Plug the small end of the headset base power adapter into the **POWER** jack (green dot) at the back of the headset base. Plug the large end into an electrical outlet not controlled by a wall switch.

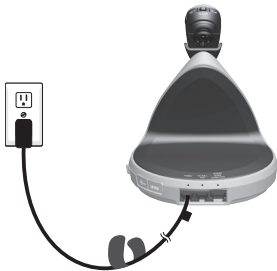

2. Insert the headset into the magnetic charging mount.

Magnetic charging mount

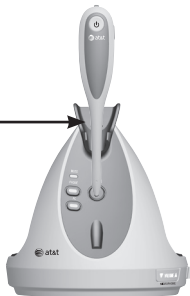

3. The magnet holds the top of the headset in place. The  light turns on.



IMPORTANT INFORMATION

Use only the supplied rechargeable battery pack or replacement battery pack (model BT191665). To order, visit our website at **www.telephones.att.com** or call **1 (800) 222-3111**. In Canada, dial **1 (866) 288-4268**.

Headset base and handset lifter installation

Installation options

There are three installation options as described below.

For Options 1 and 2, the handset lifter works with the cordless headset to provide a complete communication solution for most corded telephones. The lifter raises and lowers its switch hook presser to answer, make and end phone calls. The ring detector provides an incoming call indication through the cordless headset, so you can answer calls even when you are away from the telephone base.

Option 1: Connect the headset to a corded phone (see pages 11-12). This option allows you to use the headset to remotely control the lifter for answering or hanging up a call.

Option 2: Connect the headset to a corded phone and computer (see pages 13-16). This option enables you to use the headset for VoIP (Voice over IP) calls through your computer, or traditional phone call through the corded phone. You can use the voice command feature to make or answer calls. Make sure you install the **AT&T Softphone Call Manager** on your computer using the **CD-ROM** provided in the package. You may also visit **www.telephones.att.com/downloads** to download and install the software. For installation and operation instructions of the software, refer to the **Installation and Operation Guide** which can also be found in the **CD-ROM** provided or the web site stated above.

Option 3: If you do not want to install the lifter on the corded handset, you can simply connect the headset to a telephone wall jack through the line splitter provided (see page 17). The headset acts as a supplementary device that can join calls. Use the telephones connected to the same telephone line to make or answer calls.

Headset base and handset lifter installation

Option 1: Connect the headset to a corded phone

1. Plug one end of the corded phone connection cable into the **CORDED PHONE CONNECTION** jack (blue dot) at the back of the headset base.
2. Plug the other end of the corded phone connection cable into the handset jack on the corded phone.
3. Unplug the curly handset cord from the handset jack on the corded phone and plug it into the jack on the corded phone connection cable.
4. Plug the small end of the headset base power adapter to the **POWER** jack (green dot) on the headset base.

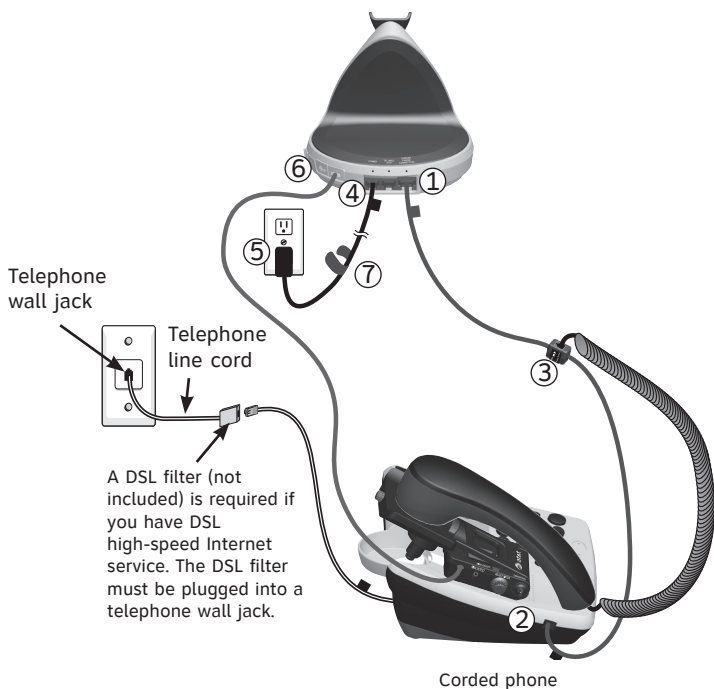

Headset base and handset lifter installation

Option 1: Connect the headset to a corded phone (cont.)

5. Plug the large end of the headset base power adapter into a power outlet not controlled by a wall switch.
6. Plug the end of the lifter control cable into the **LIFTER** jack at the back of the headset base.
7. Use the attached fastener to bundle all line cords neatly.
8. Make sure the **CORDED HANDSET CONNECTED** switch on the right side of the headset base is set to **YES**.
9. Adjust the corded handset audio (see page 18) before you install the handset lifter on the corded phone.
10. For instructions of installing the lifter, see pages 19-21. For information about the internal and auxiliary ring detectors, refer to pages 22-23.



Headset base and handset lifter installation

Option 2: Connect the headset to a corded phone and computer

1. Plug one end of the corded phone connection cable into the **CORDED PHONE CONNECTION** jack (blue dot) at the back of the headset base.
2. Plug the other end of the corded phone connection cable into the handset jack on the corded phone.
3. Unplug the curly handset cord from the handset jack on the corded phone and plug it into the jack on the corded phone connection cable.

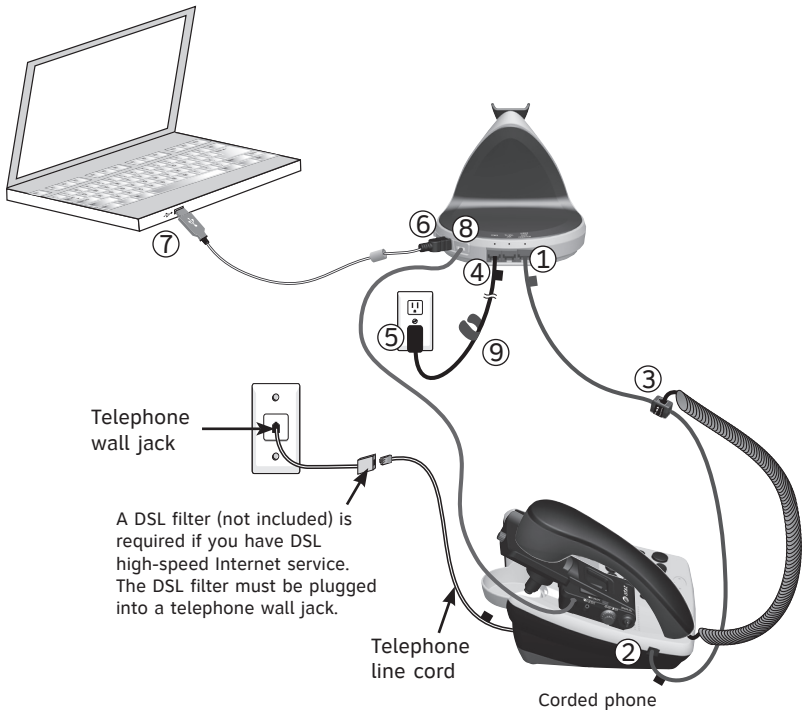

Headset base and handset lifter installation

Option 2: Connect the headset to a corded phone and computer (cont.)

4. Plug the small end of the headset base power adapter to the **POWER** jack (green dot) on the headset base.
5. Plug the large end of the headset base power adapter into a power outlet not controlled by a wall switch.
6. Plug the small end of the USB cable into the USB port labeled  on the right side of the headset base.
7. Plug the large end of the USB cable into a USB port on your computer. Wait for your computer to indicate that it has recognized the headset.
8. Plug the end of the lifter control cable into the **LIFTER** jack at the back of the headset base.
9. Use the attached fastener to bundle all line cords neatly.
10. Make sure the **CORDED HANDSET CONNECTED** switch on the right side of the headset base is set to **YES**.
11. Adjust the corded handset audio (see page 18) before you install the handset lifter on the corded phone.
12. For instructions of installing the lifter, see pages 19-21. For information about the internal and auxiliary ring detectors, refer to pages 22-23.
13. Install the **AT&T Softphone Call Manager** using the **CD-ROM** provided in the package. You may also visit www.telephones.att.com/downloads to download and install the software. For installation and operation instructions of the software, refer to the **Installation and Operation Guide** which can also be found in the **CD-ROM** provided or the web site stated above.



Headset base and handset lifter installation

Option 2: Connect the headset to a corded phone and computer (cont.)

14. After you have installed the **AT&T Softphone Call Manager**, check to make sure the audio setting is properly configured in your Windows system. If you have installed Skype and/or Microsoft Lync and want to use them with your headset, make sure the audio settings are configured correctly in the programs as well.

a) Audio settings in Microsoft® Windows® system:

For Windows XP® users:

- i. Click **Start** menu and choose **Control Panel**.
- ii. Click **Sounds, Speech, and Audio Devices** and then click **Sounds and Audio Devices**.
- iii. Click the **Audio** tab.
- iv. Make sure **AT&T DECT Headset** is selected under the **Sound playback** and **Sound recording** settings.

For Windows 7 users:

- i. Click **Start** menu and choose **Control Panel**.
- ii. Click **Hardware and Sound** and then click **Manage audio devices** under the **Sound** menu.
- iii. Click the **Playback** tab and make sure **AT&T DECT Headset** is set as the default speaker.
- iv. Click the **Recording** tab and make sure **AT&T DECT Headset** is set as the default microphone.

Headset base and handset lifter installation

Option 2: Connect the headset to a corded phone and computer (cont.)

b) Audio settings in Skype:

- i. Launch the Skype program.
- ii. Click on **Tools**, then **Options**.
- iii. Click on **Audio settings**.
- iv. Make sure **AT&T DECT Headset** is selected under the speakers and microphone settings.

c) Audio settings in Microsoft Lync:

- i. Launch the Microsoft Lync program.
- ii. Click on **Options**, then **Audio Device**.
- iii. Make sure **AT&T DECT Headset** is selected under the Audio device setting.

IMPORTANT



Periodically check for software updates. Go to the **ABOUT** tab under the **Settings** panel in the **AT&T Softphone Call Manager**, then click **Check Update**. For more details, refer to the **Software updates** section in the **Installation and Operation Guide**, available in the **CD-ROM** which comes with the package.

Headset base and handset lifter installation

Option 3: Connect the headset to a telephone wall jack

1. Make sure the **CORDED HANDSET CONNECTED** switch on the right side of the headset base is set to **NO**.
2. Connect the line cords as shown below. Use the included line splitter to connect the headset base and your telephone to the same telephone wall jack.

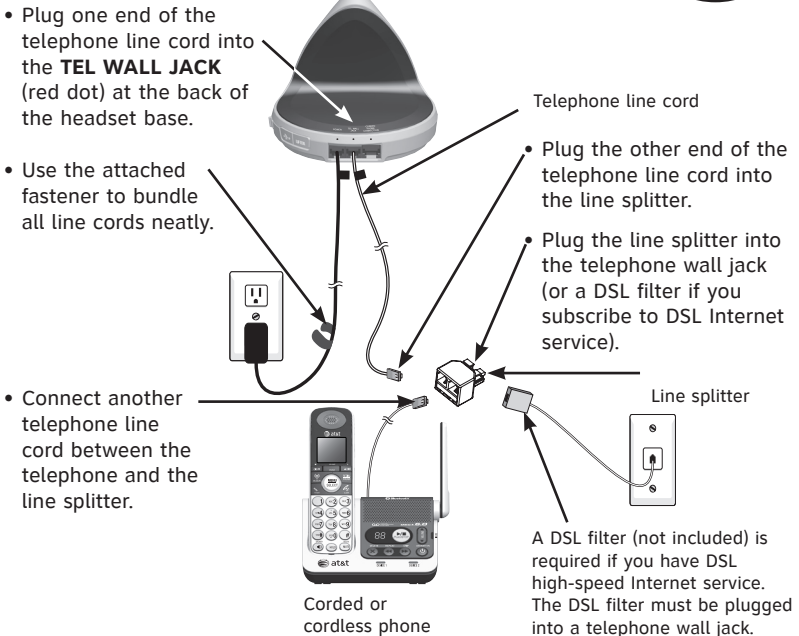

NOTE: The headset base and headset do not have external ringers. When you receive calls, the headset earpiece rings. If you have telephones connected to the same telephone line as the headset base, you can rely on the ringers of those telephones to alert you to incoming calls.

Headset base and handset lifter installation

Adjust the corded handset audio

After you have connected the headset base to your corded phone, you may need to adjust the corded handset audio switch at the bottom of the headset base for optimal sound quality.

To adjust the corded handset audio:

- Lift the corded handset and then press **⓪** on the headset to check for a dial tone. If there is no dial tone or the dial tone is unclear, slide the corded handset audio switch at the bottom of the headset base from **A** to **F** until the dial tone is clear.

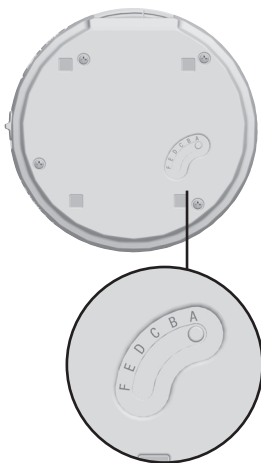

Headset base and handset lifter installation

Attach the lifter

1. To choose where to install the lifter on your telephone, look at the space underneath the corded handset. If there is a speaker, the lifter should be centered over the speaker. If there is no speaker, the lifter should be centered within the space. Make sure the lifter arm is raised above the switch hook of the telephone base.
2. Peel off the protective strips from the adhesive tape at the bottom of the lifter.
3. Carefully place the lifter in the desired position and press down.
4. Plug the lifter control cable into the **LIFTER** jack on the headset base.

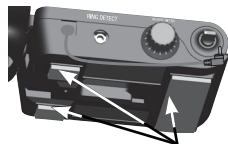

Adhesive tape

Headset base and handset lifter installation

Adjust the switch hook presser position

Turn the knob to move the switch hook presser until it is lined up with your telephone switch hook.

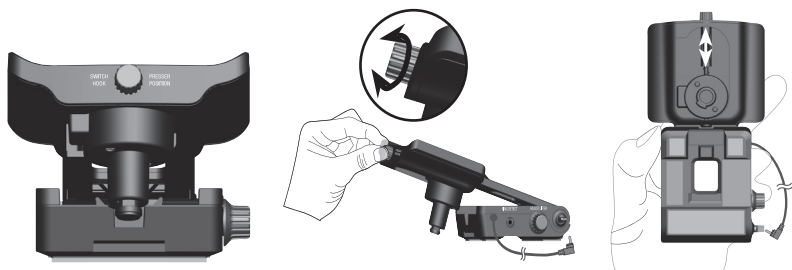

Adjust the height of the lifter arm

Turn the **ADJUST LIFTER** knob to change the height of the lifter arm. When in the raised position, the arm should release the switch hook so you can hear a dial tone. When lowered, the arm should hold the switch hook down so you cannot hear a dial tone.

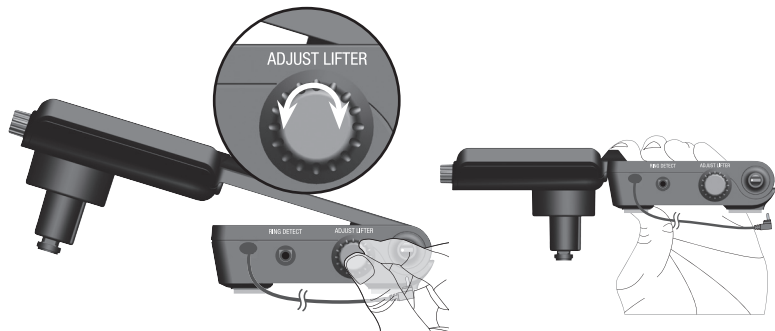

Headset base and handset lifter installation

Lifter adjustments and testing

1. Make sure that the **CORDED HANDSET CONNECTED** switch on the headset base is set to **YES**.
2. Turn the switch hook presser adjustment knob until the switch hook presser is just above the switch hook (see page 20).
3. Lower the lifter arm until the switch hook presser holds the switch hook down.
4. Place the corded handset on the lifter.
5. Press **⏻** on the headset. The switch hook presser should rise and release the switch hook on your telephone base. Make sure you hear a dial tone through your headset earpiece.
6. If the switch hook is not fully released, turn the **ADJUST LIFTER** knob (see page 20) while the corded handset is on the lifter. When the switch hook is fully released, you will hear a dial tone from the headset.

It may take some adjustments and testing to find the right position for the lifter. For the lifter to work properly, the switch hook must release completely when you press **⏻** and turn the headset on. The switch hook must also be held down completely when you press **⏻** and turn the headset off.

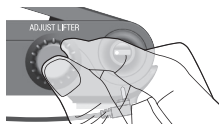

About internal and auxiliary ring detectors

The internal or auxiliary ring detector detects the telephone ringer and sends a ring tone to the headset earpiece.

If you installed the lifter over the top of the corded phone speaker, the internal ring detector will recognize when the phone rings. However, if your corded phone speaker is located elsewhere on the phone, stick the auxiliary ring detector to the speaker as shown below.

Install the auxiliary ring detector

1. Insert the auxiliary ring detector plug into the **RING DETECT** jack on the lifter.
2. Remove the protective strip from the adhesive tape on the auxiliary ring detector.
3. Stick the auxiliary ring detector to the center of the corded phone speaker.

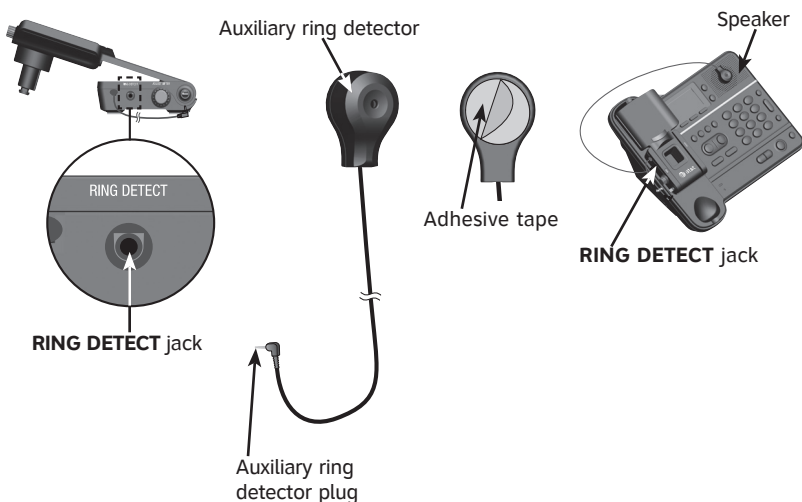

About internal and auxiliary ring detectors

Ring detector on/off

When the ring detector detects an incoming call, it sends a ring tone to the headset earpiece.

- Press the **RING ON/OFF** button on the lifter to turn the ring detector on or off. The **STATUS** light is blue when the ring detector is turned on. The **STATUS** light is red when the ring detector is turned off.
- When the ring detector is turned off, it does not send a ring tone to the headset. The  light on the headset does not flash when there is an incoming call.



 **NOTE:** When you are using the speakerphone of your telephone, the ring detector may send a ring tone to the headset. If you do not want the headset to ring, press the **RING ON/OFF** button to turn the ring detector off. After the call, you can press the **RING ON/OFF** button again to turn the ring detector back on.

Adjust the sensitivity level

The default setting of the ring detector works with most corded telephones. However, the ring detector might need some adjustments if the ring tone level of your corded phone is too soft.

To adjust the ring detector sensitivity while the telephone is ringing:

- Turn the **SENSOR ADJ** knob clockwise to increase the sensitivity.
- Turn the **SENSOR ADJ** knob counterclockwise to decrease the sensitivity.



When the ring detector detects the telephone ringer correctly:

- The **STATUS** light on the lifter flashes quickly when the telephone rings.
- The detector sends the ring tone to the headset earpiece.

Headset attachments

Earbud

There are a total of six earbuds provided. One of them has been attached to the headset. They come in three sizes of which there are two types: one normal and one providing a deeper fit. Follow the steps below to change the earbud.

To remove the earbud from the headset earpiece:

Hold both sides of the earbud. Twist and pull the earbud until it separates from the earpiece.

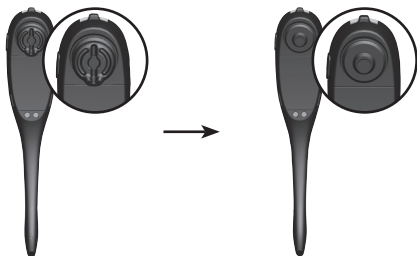

To attach the earbud to the headset earpiece:

1. Choose an appropriate earbud.
2. Position the earbud on the earpiece as shown below.
3. Press the earbud down on the earpiece until it clicks into place. Move the earbud around so that the protruding bump on the earbud is pointing towards your mouth when placed on your ear.

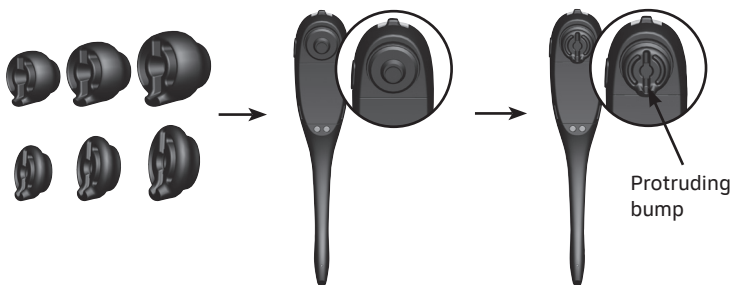

Headset attachments

Over the ear hook

There are three ear hooks provided. Choose the size that best fits your need to attach to the headset. Follow the steps below to attach an ear hook to the headset.

To position the headset to wear on the left or right ear:

- To wear on the left ear:
 1. Make sure the ear hook loop is positioned, as shown in Figure 1 on the right.
 2. Attach the ear hook to the headset as instructed on the next page.



Figure 1

- To wear on the right ear:
 1. Make sure the ear hook loop is positioned, as shown in Figure 2 on the right.
 2. Attach the ear hook to the headset as instructed on the next page.

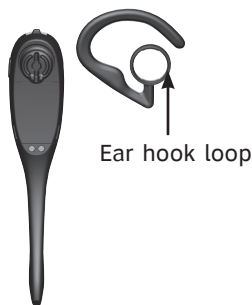

Figure 2

Headset attachments

To attach the ear hook to the headset:

1. Make sure there is no headset attachment, except the earbud, connected to the headset.
2. Insert the earpiece into the ear hook loop, as shown in Figure 3.
3. Press the edge of the ear hook loop towards the earpiece until it clicks into place, as shown in Figure 4.
4. Hook the headset onto the desired ear. Adjust the angle of the headset until the microphone is pointing towards your mouth, as shown in Figure 5.

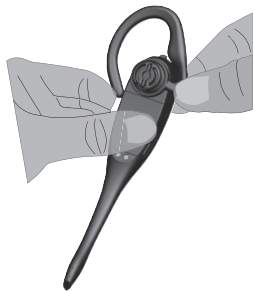

Figure 3

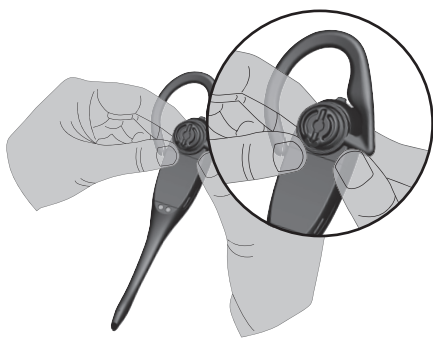

Figure 4

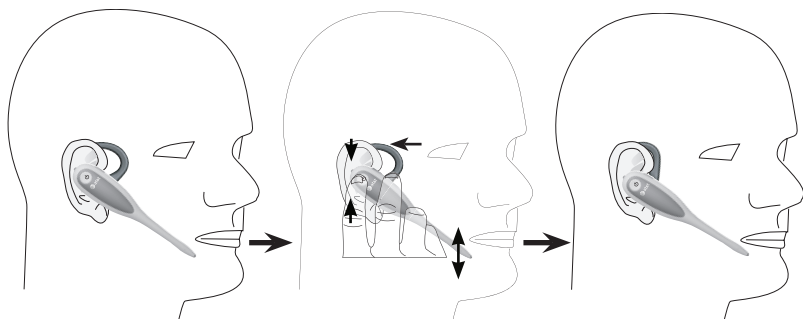

Figure 5

Headset attachments

Over the head band

There are two over the head bands provided. Choose the one that best fits your need to attach to the headset. Follow the steps below to attach an over the head band to the headset.

To attach the head band to the headset:

1. Make sure there is no headset attachment, except the earbud, connected to the headset.
2. Insert the earpiece into the loop of the ear pad, as shown in Figure 6.
3. Push the earpiece into the ear pad until it clicks into place, as shown in Figure 7.
4. Adjust the head band to fit your head. Adjust and rotate the angle of the headset until the microphone is pointing towards your mouth, as shown in Figure 8.

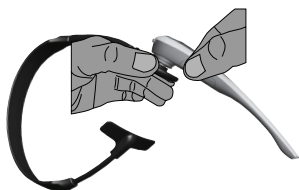

Figure 6

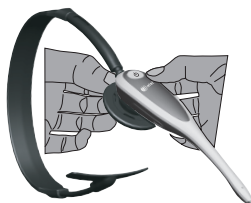

Figure 7

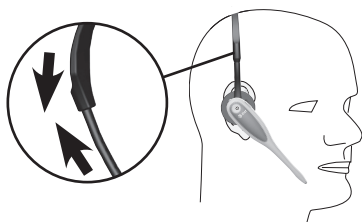

Figure 8



NOTES:

- To wear on the other ear, rotate the headset within the loop of the ear pad.
- Firmly grip the ear pad with one hand whenever adjusting the headset microphone up or down.

Headset attachments

Behind the neck band

By default, the ear pad on the neck band is positioned to be worn on the right ear.

To attach the headset to the neck band:

1. Make sure there is no headset attachment, except the earbud, connected to the headset.
2. Insert the earpiece into the loop of the ear pad, as shown in Figure 9.
3. Gently press the earpiece inward until it clicks into place, as shown in Figure 10.
4. Place the neck band around your neck and over your ears.
5. Adjust and rotate the angle of the headset until the microphone is pointing towards your mouth, as shown in Figure 11.



Figure 9



Figure 10

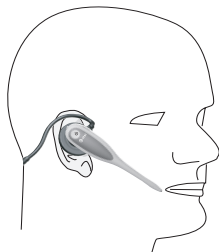

Figure 11

Headset operation

Power on/off the headset

Power on the headset before use.

To power on the headset:

- Place the headset in the headset base.

-OR-

- Press and hold  for two seconds.

The  light flashes blue three times and you hear three beeps when it is being powered on.

Power off the headset if it will not be used for a long time.

To power off the headset:

- Press and hold  for four seconds.

The  light flashes red three times and you hear three beeps when it is being powered off.



Prolonged exposure to high volume levels using the headset may damage your hearing.

PHONE mode and PC mode

Before using the headset, you may change the default mode of your headset. When the headset is not in use and you press , your headset automatically switches to the default mode you selected. When the headset is not in use, you can choose between PHONE mode and PC mode.

To choose PHONE mode:

- Press the **PHONE** button on the headset base. The **PHONE** light turns on.

To choose PC mode:

- Press the **PC** button on the headset base. The **PC** light turns on.

PHONE mode

Make a call

To make calls on your home or office telephone line, press **PHONE** on the headset base for PHONE mode.

When the headset base is connected to the corded handset of your telephone with the handset lifter installed:

1. Press **⓪** on the headset. The switch hook presser rises and releases the switch hook. You hear a dial tone in the headset earpiece.
2. Dial the telephone number using the dialing keys.

When the headset base is connected to a telephone wall jack:

1. Follow the instructions in your telephone user's manual for making calls.
2. Press **⓪** on the headset at any time to join the call.
3. After you join the call, you can hang up the telephone and continue the call on the headset.



NOTES:

- You cannot switch a call from the headset to the corded handset.
- If you plug the headset into a telephone line without a telephone connected, you are unable to make calls.

Answer a call

When the headset base is connected to the corded handset of your telephone with the handset lifter installed:

- Press **⓪** on the headset to answer an incoming call. The switch hook presser rises and releases the switch hook. You hear the caller through the headset earpiece.

When the headset base is connected to a telephone wall jack:

- Press **⓪** on the headset.

PHONE mode

End a call

When the headset base is connected to the corded handset of your telephone with the handset lifter installed:

- Press Φ on the headset to end a call. The switch hook presser pushes down the switch hook and ends the call.

When the headset base is connected to a telephone wall jack:

- Press Φ on the headset or place the headset in the headset base.



www.telephones.att.com

© 2012-2013 Advanced American Telephones. All Rights Reserved.
AT&T and the AT&T logo are trademarks of AT&T Intellectual Property licensed to
Advanced American Telephones, San Antonio, TX 78219.

The Skype name is a trademark of Skype.

Microsoft Lync is a registered trademark of Microsoft Corporation.

Windows® and Windows XP® are registered trademarks of Microsoft Corporation.

Synapse® and SynJ® are trademarks of Advanced American Telephones.

Printed in China. Issue 6 AT&T 06/13