

Go to www.vtechphones.com to register your product for enhanced warranty support and latest VTech product news.

VM351-2



vtech

Quick start guide

What's in the box

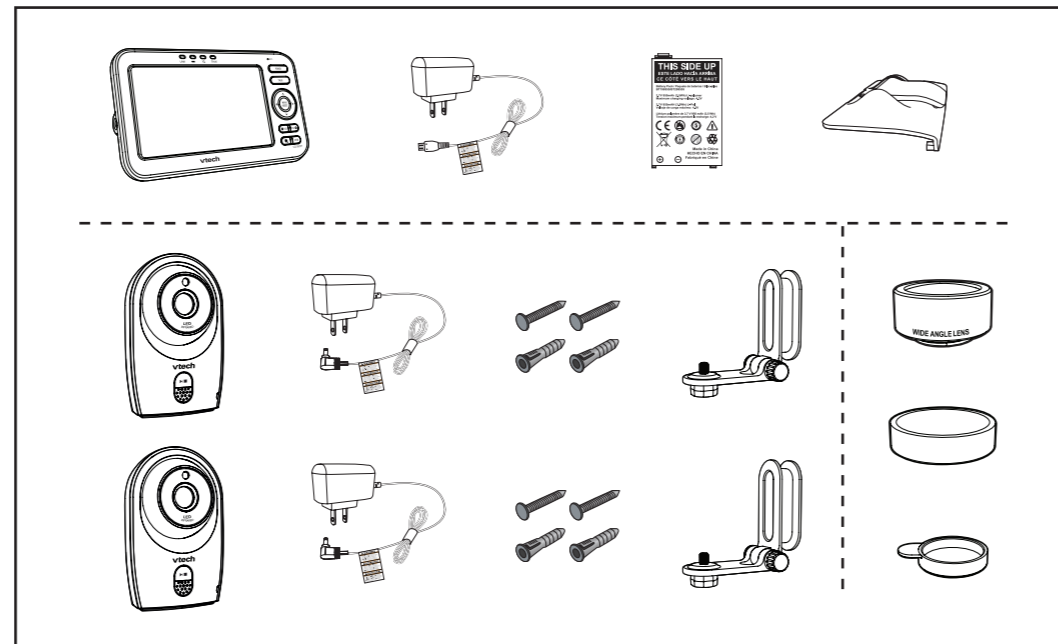

VM351-2 baby monitor system

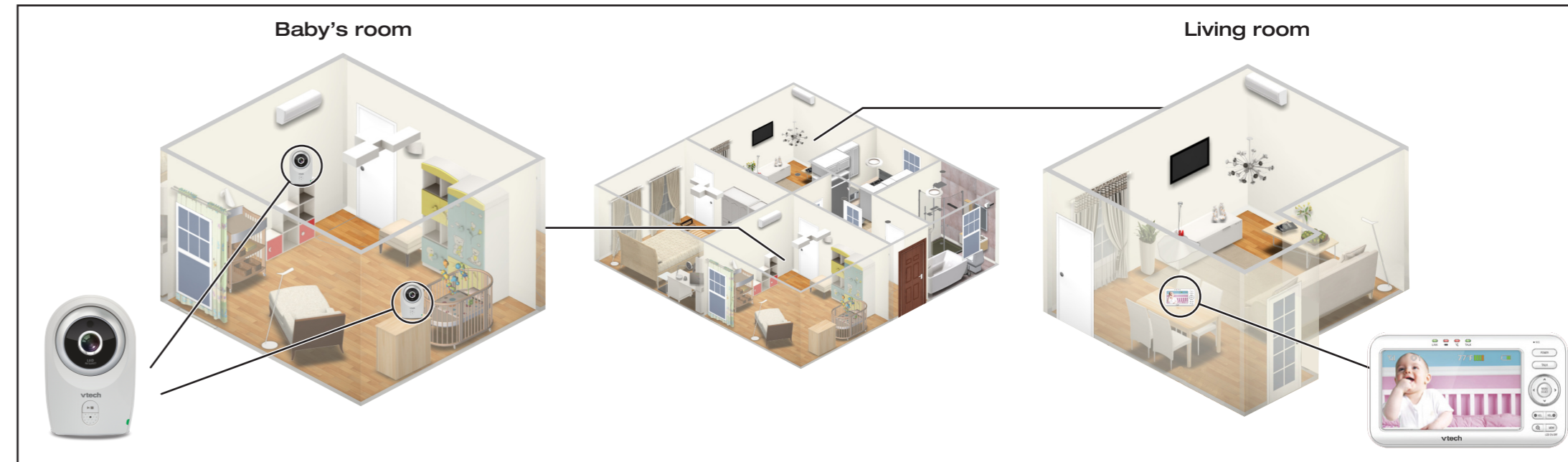

1 Connect and power on - Baby unit

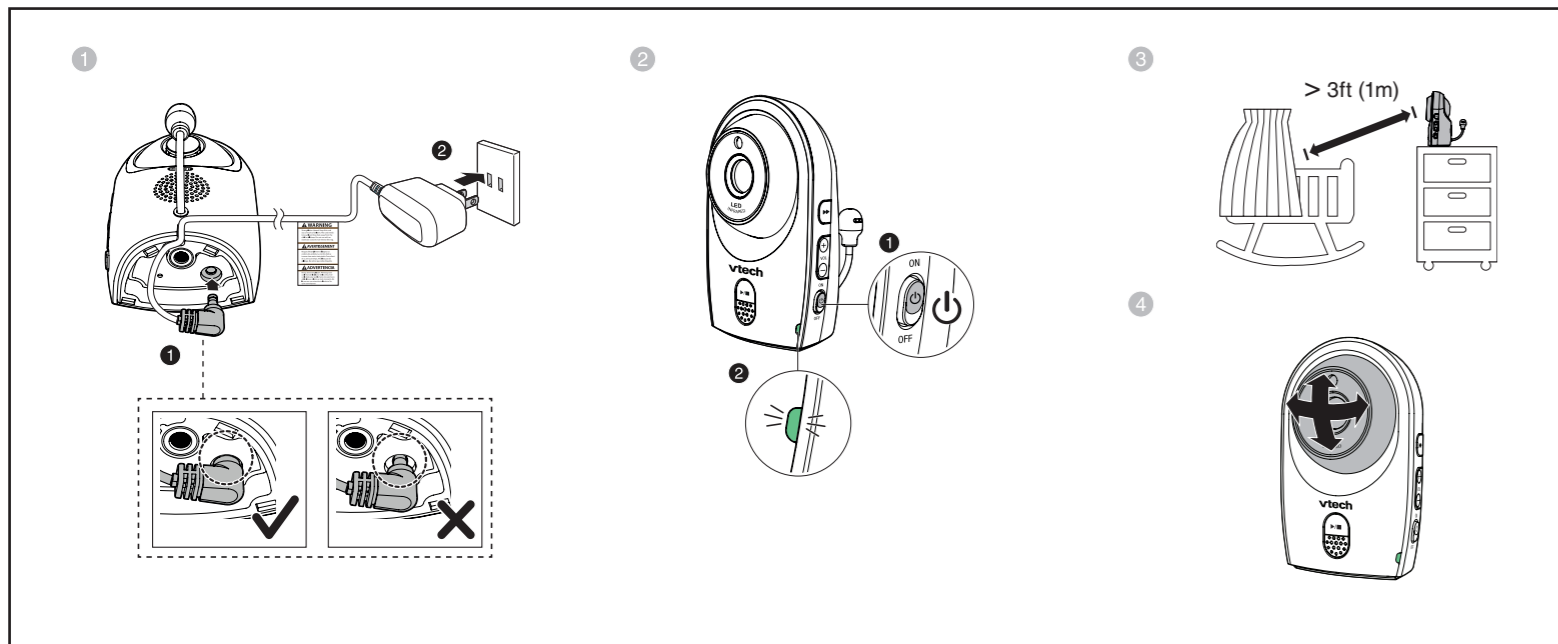

2 Install the battery

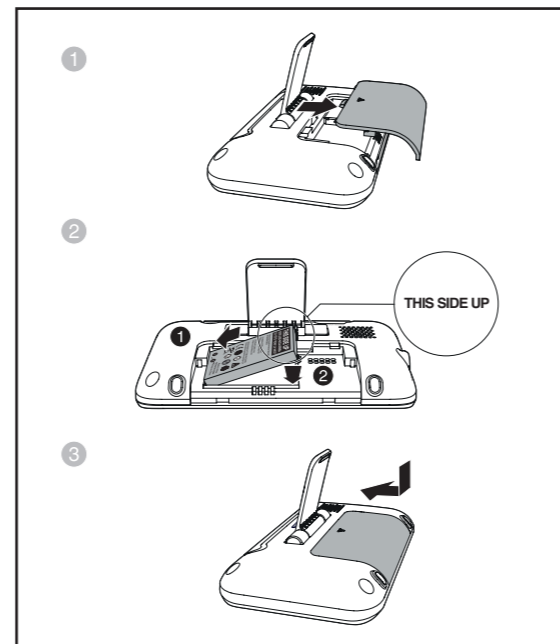

3 Connect and power on - Parent unit

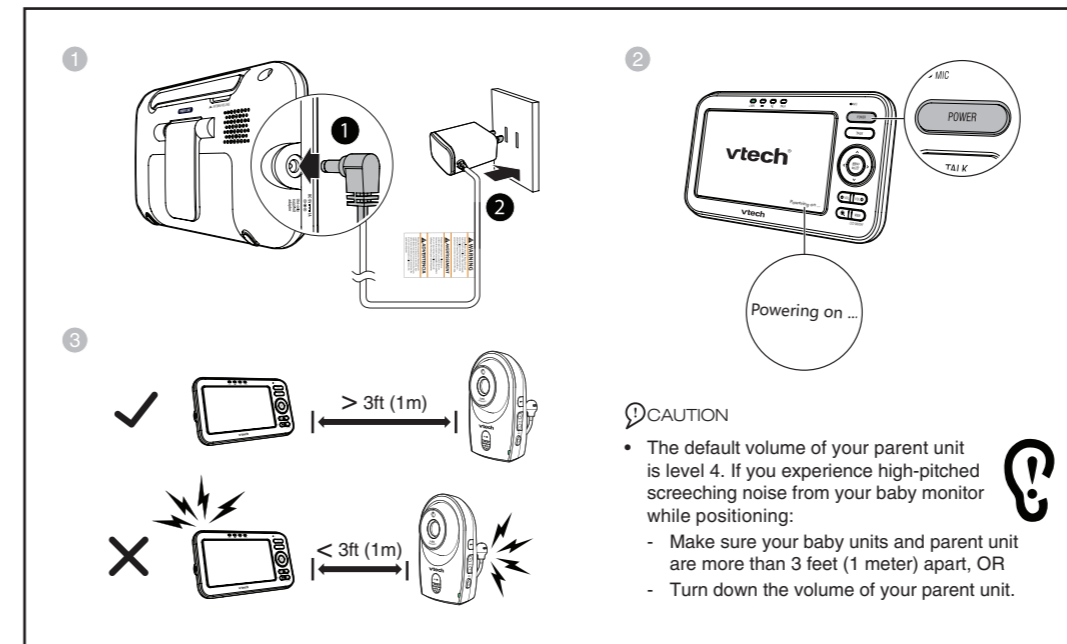

4 Status check

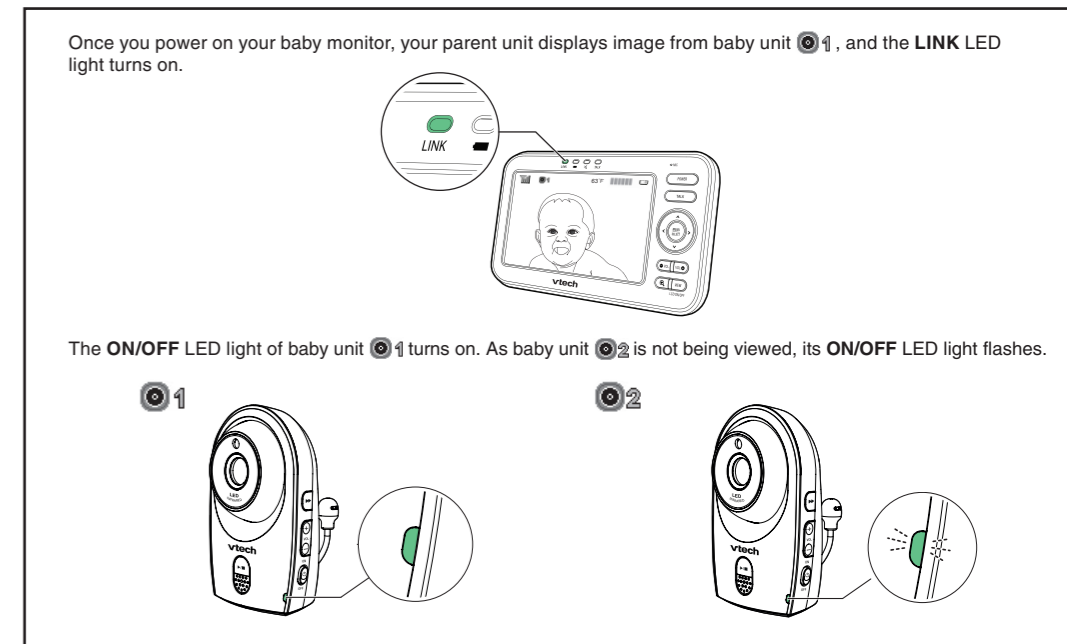

Change different views - Single CAM

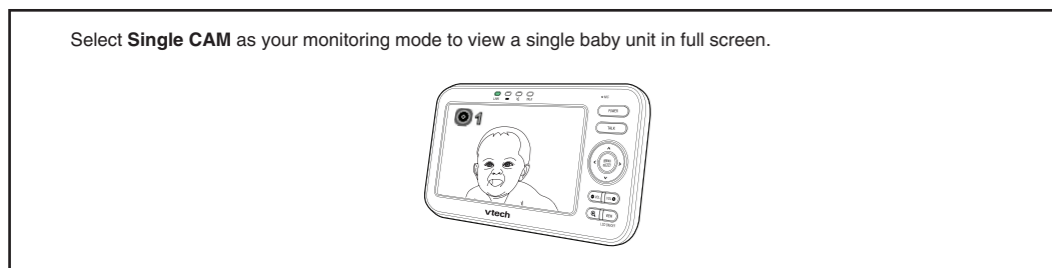

Change different views - Patrol

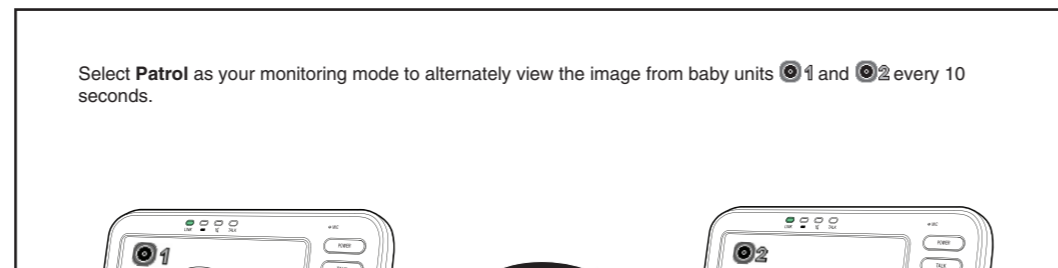

Change different views - Split

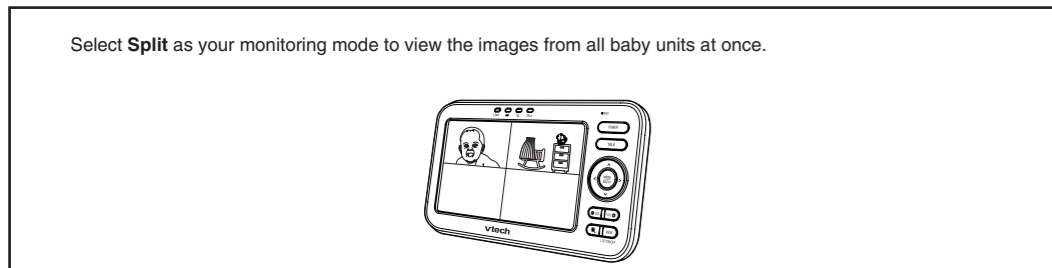

Change different views

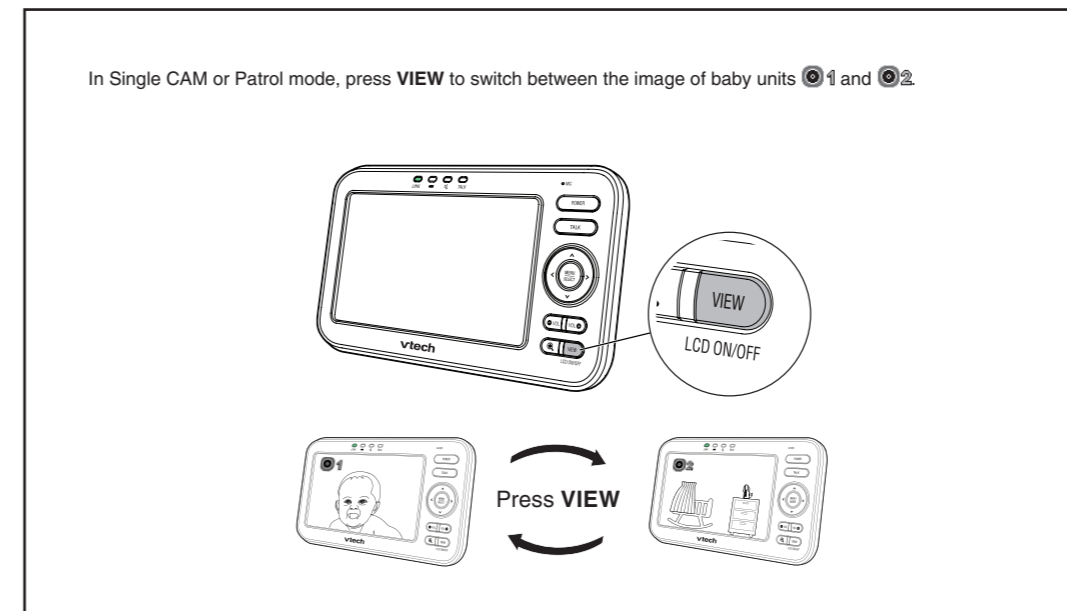

Dim mode

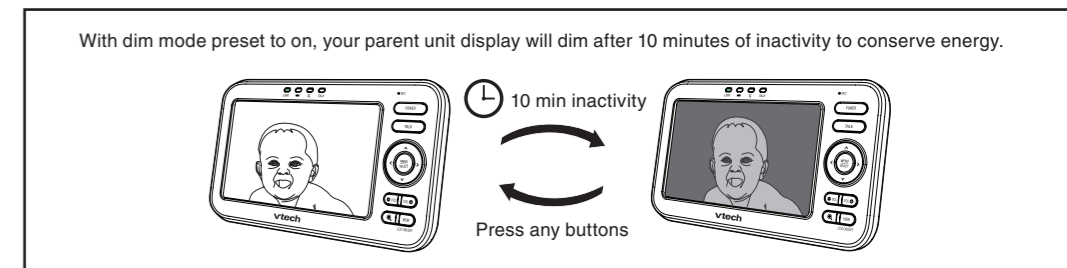

Install the lens (optional)

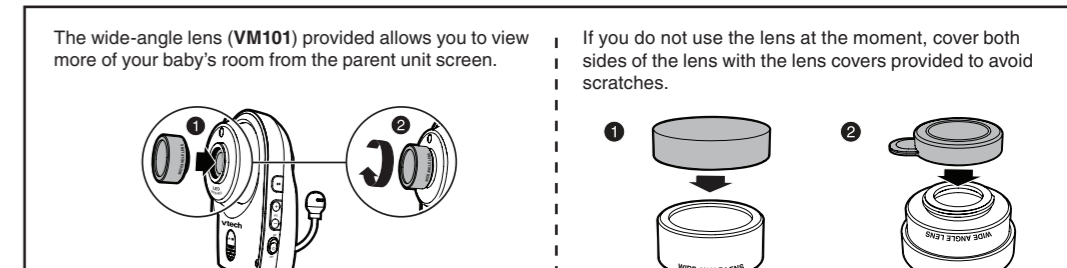

Sound activation

Automatically turns on the parent unit screen when the baby unit being viewed detects a sound after the screen is turned off. When no sound is detected within 50 seconds, the screen is automatically turned off to save power.

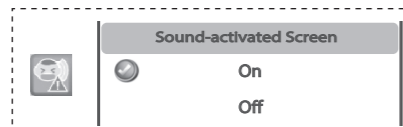
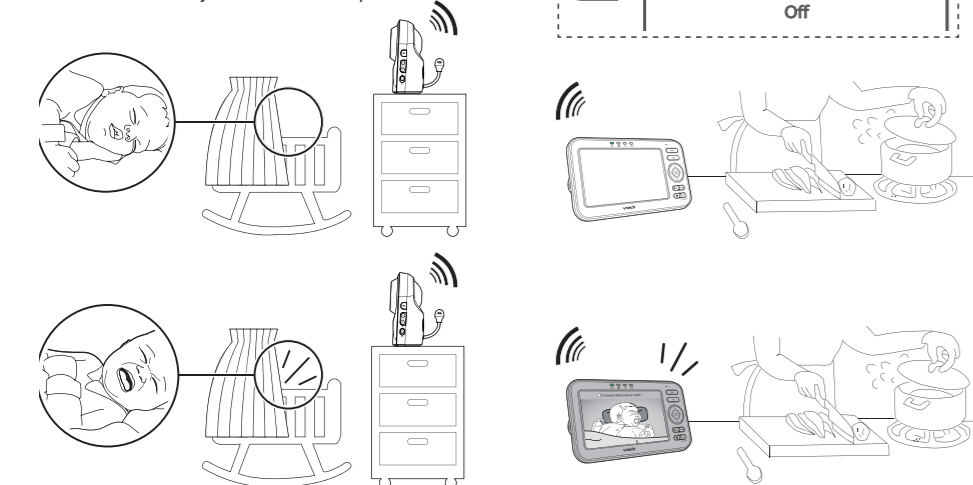

Overview - Parent unit

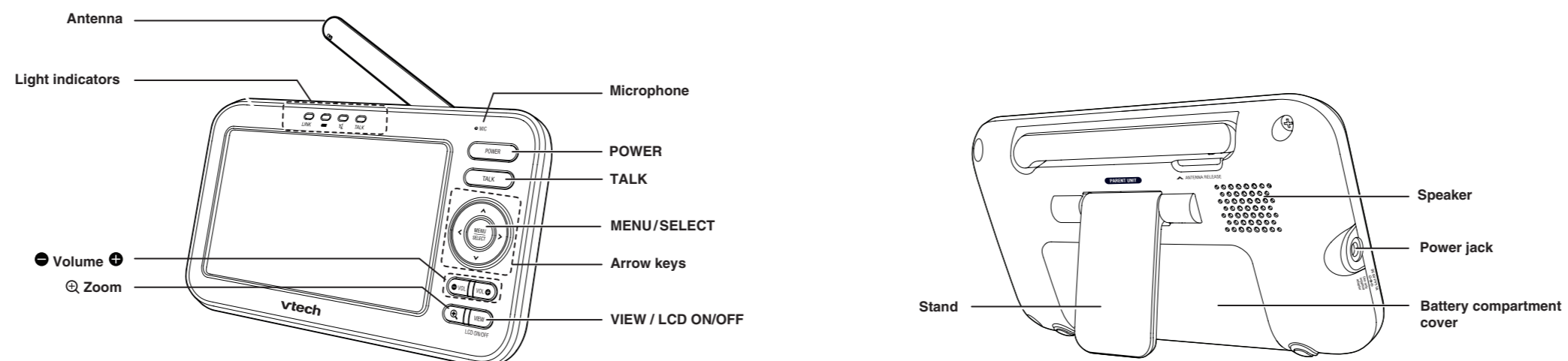

Overview - Baby unit

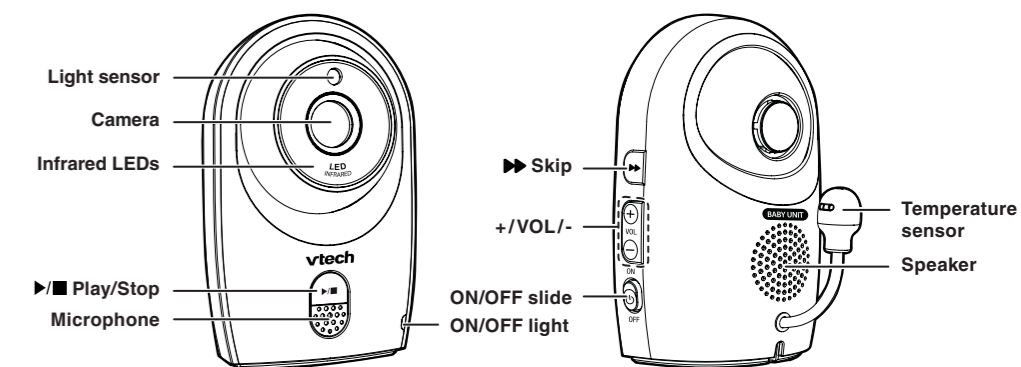

Basic operation - Parent unit

Adjust speaker volume

Press **+/VOL/-** to adjust your parent unit speaker volume. It determines the volume of sound transmitted from your baby units.

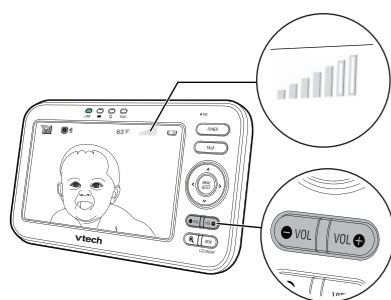

Zoom

Press **Q** to zoom in or out.

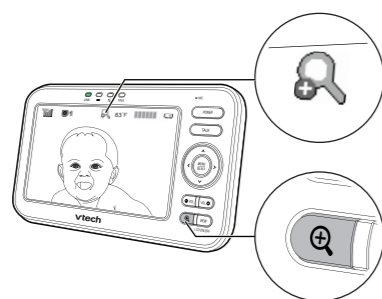

Talk to your baby unit

Press and hold **TALK** and speak to your parent unit. Your voice is transmitted to the baby unit.

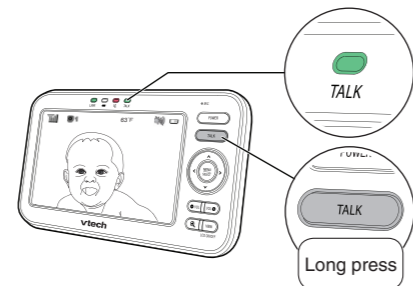

Turn off the screen

Press and hold **LCD ON/OFF** to switch off the screen. You can still hear sound from the selected baby unit.



Use the menu

Press **MENU/SELECT** to enter the menu, choose a menu item, or save a setting.

- While in the menu:
- Press **▲** or **▼** to scroll up or down.
 - Press **▶** to select an item.
 - Press **◀** to return to the main menu or idle screen.

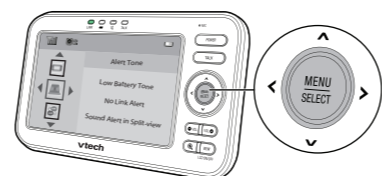

Turn off the parent unit

Press and hold **POWER** to power off your parent unit.

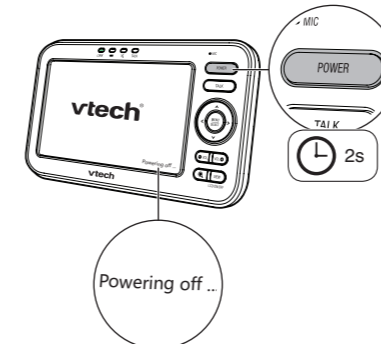

Basic operation - Baby unit

Adjust speaker volume

Press **+/VOL/-** to adjust your baby unit speaker volume. It determines the lullaby volume and talkback volume transmitted by your parent unit.

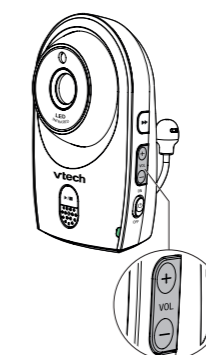

Lullaby

Press **▶/■** to play lullaby on the baby units.

- Press **▶▶** to skip to the other lullabies.
- Press **▶/■** again to stop the lullaby.

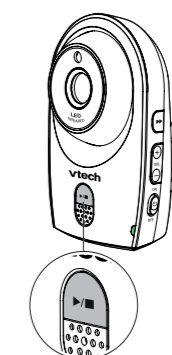

Turn off the baby unit

Slide the **ON/OFF** switch to **OFF** to power off your baby unit.



Night vision



The baby unit has infrared LEDs that allow you to see your baby at night or in a dark room. When the baby unit detects low light levels, the infrared LEDs turn on automatically. The image from this baby unit is in black and white, and appears on screen.

NOTES

- It is normal if you see a short white glare on your parent unit screen as the baby unit is adapting to the dark environment.
- When the infrared LEDs are on, the image is in black and white. This is normal due to external light sources.

TIP

- Depending on the surroundings and other interfering factors, like lightings, objects, colors and backgrounds, the display resolution may vary. Adjust the baby unit's angle, or place the baby unit at a higher level to prevent glare and blurry display.

Mount the baby monitor (optional)

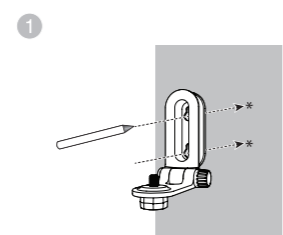

NOTE

- Check for reception strength and camera angle before drilling the holes.

Place the wall mount bracket on a wall and then use a pencil to mark the top and the bottom holes as shown. Remove the wall mount bracket and drill two holes in the wall (7/32 inch drill bit).

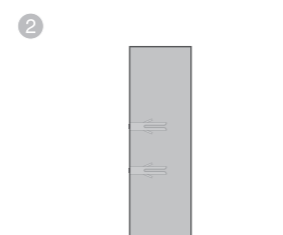

If you drill the holes into a stud, go to step 3.

-OR-

If you drill the holes into an object other than a stud, insert the wall anchors into the holes. Tap gently on the ends with a hammer until the wall anchors are flush with the wall.

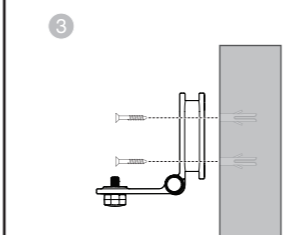

Align the wall mount bracket and screws with the holes in the wall as shown. Tighten the screw in the middle hole first, so that the wall mount bracket position is fixed. You can tighten the other screw in the top hole.

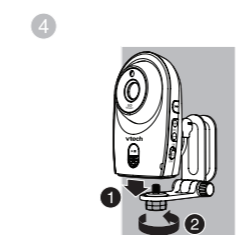

Place the baby unit on the wall mount bracket. Tighten the screw into the threaded socket at the bottom to secure the baby unit.

OR

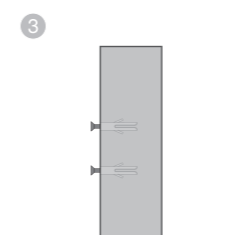

Insert the screws into the holes and tighten the screws until only 1/4 inch of the screws are exposed.

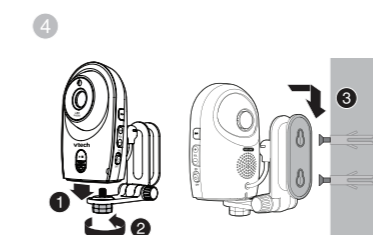

Place the baby unit on the wall mount bracket. Tighten the screw into the threaded socket at the bottom to secure the baby unit. Align the holes on the wall mount bracket with the screws on the wall, and slide the wall mount bracket down until it locks into place.

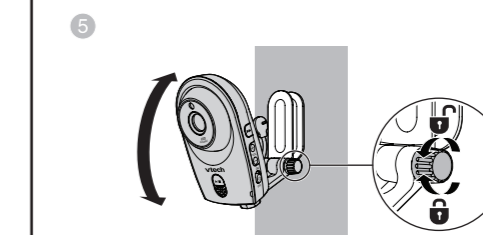

The default angle of the wall mount bracket is 90 degrees. You can maximize your baby unit's viewing angles by tilting the wall mount bracket.

Hold the baby unit, and then rotate the knob in anticlockwise direction. This will loosen the joint of the wall mount bracket. Tilt your baby unit up or down to adjust to your preferred angle. Then, rotate the knob in clockwise direction to tighten the joint and secure the angle.

